



survitecgroup

# COMMERCIAL MARINE CATALOG

NORTH AMERICA  
SUPPORT | SERVICE | SAFETY



[www.survitecgroup.com](http://www.survitecgroup.com)



# OUR MISSION IS YOUR SURVIVAL

Survitec Group is recognized as the worldwide leader in the manufacturing, supply, inspection, testing and maintenance of mission-critical safety and survival equipment. We provide service and support for a diverse range of customers in the Commercial Marine, Offshore Oil and Gas, Aviation, Defense, Emergency Services, Renewable Energy and Industrial markets.

Survitec Group has been helping to save lives at sea for over 160 years. From common-use safety items to products of last resort, our equipment and services are respected and relied upon in all corners of the world.

In North America, our wide portfolio of products is distributed through an integrated network of local Distributors, Master Distributors and Elite Distributors. We believe it takes strong partnerships between manufacturers and distributors to bring the best value, highest quality safety and survival equipment to end users ... and we consider each of our Distributors to be our partner.

Many of our strongest partners are approved service stations, authorized to service liferafts, MES (Marine Evacuation Systems), rescue boats, lifeboats, fire-fighting equipment, lifejackets, immersion suits, safety beacons and gas detection systems. Each service station is strategically located to cover a major port, ensuring minimum delay in the delivery, collection and servicing of equipment.

As you will learn in the coming pages, our Distributors and their end users benefit from a comprehensive range of innovative products, each of which has been carefully designed and manufactured to stringent quality standards. But this is not the end of the story.

As innovators with a passion for developing new products and services to meet the changing demands of our customers, we pride ourselves on delivering great service. Although our business interests span many countries and markets, our people, our products and our partners share a common mission... your survival.



Nick Howland  
Vice President and Managing Director  
Survitec Group North America

## WORKBOATS

Survitec Group products are built to be as tough as the people who use them and the ships they are on. Be it a tug, container ship, or something else... our products rise to meet the challenge.



## CRUISE SHIPS

Survitec Group is the market leader in supply and service for innovative marine survival solutions to the full range of sea-going vessels.



## OFFSHORE & OIL EXPLORATION

Our wide-ranging knowledge and expertise means we can offer extensive support whether you are close to shore or far out to sea.



## FIRE-FIGHTING & PUBLIC SAFETY

Survitec has the in-depth understanding required to advise customers on the best products for fire and public safety applications.



## COMMERCIAL FISHING

We know it is harder than ever to make a living harvesting the sea, so our service stations strive to keep your equipment working and safe so you continue to be successful.



# CONTENTS

## ABOUT SURVITEC GROUP

Corporate Offices In North America	5 - 6
Distributor & Service Station Locations	7 - 8
Global Liferaft Lease	9
Servicing	10
Air/Sea Fire & Safety	11

## LIFERAFTS

Choosing The Right One	101 - 102
Throw-Over Liferrafts	103 - 114
Decelerating System	115
Liferaft Container Roll-off Cradles	115
Davit-Launch Liferrafts	116 - 121
Coastal Liferrafts	122 - 125
IBA Liferrafts	126 - 130
Means Of Rescue	131
Liferaft Accessories	132

## MARINE EVACUATION SYSTEMS

Choosing The Right One	201 - 202
Low Evacuation Height	203 - 205
Medium Evacuation Height	206 - 208
High Evacuation Height	209 - 211
Offshore	212 - 213

## SOLAS RESCUE & WORKBOATS

Rigid Inflatable Boats	301
Rescue and Workboats	302

## DAVITS

Choosing The Right One	401
Liferaft Davit	402
Rescue Boat Slewing Davit	403
Fast Rescue Boat Davit	404
Release Hook	405

## PYROTECHNICS

Kits	501 - 502
Flares & Smokes	502 - 503
Rockets & Line Thrower	504
Containers	505

## PERSONAL FLOTATION

Choosing The Right One	601 - 602
Personal Flotation Devices	603 - 608
Inflatable Lifejackets	609 - 610
PFD Parts And Accessories	611 - 612

## RESCUE EQUIPMENT & MARINE ACCESSORIES

Personnel Recovery Device	701
Rescue Ramp	702
Drysuits	703
Helmets and Rescue Rope	704
Marine Accessories	705

## SURVIVAL SUITS

Immersion Suits	801 - 802
Ice Rescue Suit	803

## ELECTRONICS

Choosing The Right One	901 - 902
EPIRBs	903 - 904
PLBs	905
Personal AIS	906
SARTs	907
GMDSS Radio and Beacon HRU	908

## TRAINING & MARKETING MATERIALS

Marketing Support & Fulfillment	1001
Customer Advertising Allowance Plan	1002
Exhibition Sponsorship	1003
Product Dummies & Samples	1004 - 1005
Literature	1006
Signage	1007
Other Materials	1008

## DOING BUSINESS WITH SURVITEC

Welcome To Our Family	1101
Setting Up Your Account	1102
Survitec Survivor Club	1003
Survitec Group Website	1104
Survitec Station Websites	1105
FTP Resource Site	1106

# ICONS KEY

This catalog is organized into categories so that readers may easily and intuitively retrieve relevant information on the products and services they are interested in. Additionally, icons are used to reference key product information. These icons are described as follows:

## ORDERING LOCATION

The icons shown to the right are located in product listings and should be used to reference which office in North America offers the product for ordering. Contact information is located on page 5.



Survitec Group in Jacksonville, FL



Survitec Group in Houston, TX



Survitec Group in Sharon Center, OH



Survitec Group in Miami, FL



Survitec Group in Vancouver, BC

## APPROVAL CLUSTER

Many of the products that Survitec Group offers are legislatively regulated by North American public and private institutions. Each category has a slightly different approval cluster, and applicable approvals are highlighted in Survitec Group Orange. The clusters are located directly adjacent to the product image. Examples are shown to the right with descriptions below.

USCG Approval: The United States Coast Guard (USCG) has developed specifications and criteria for marine safety equipment. Every unit will have a label or printing directly on the device identifying the approval number.

TC Approval: Transport Canada promotes efficient marine transportation and safe, secure and sustainable marine practices; oversees marine infrastructure; regulates the safe transportation of dangerous goods by water; and helps protect the marine environment.

SOLAS Compliance: The “International Convention for Safety of Life at Sea” has existed since 1914. The International Maritime Organization (IMO) has maintained and developed the SOLAS standards since 1948.

MED Approval: Council Directive 98/85/EC of December 20 1996 on Marine Equipment came into force on January 1, 1999, and applies to all ships whose safety certification is issued by or on behalf of Member States of the European Union.

CE Approval: The mark is placed on products that meet safety standards that apply to all the countries of the European Union. Products with CE approval can be traded freely throughout the EU without further modification or testing. The CE marking or formerly EC mark, is a mandatory conformity marking for certain products sold within the European Economic Area (EEA) since 1993.



Liferafts, MES, Rescue Boats Davits And Survival Suits



Personal Flotation Devices And Survival Suits

## OTHER INDICATORS



Indicates a Dummy or Sample Product is available free of charge to authorized customers with approval by your Sales Manager; see Training & Marketing Materials section for applicable information.



Standard case quantity of pyrotechnics, PFDs and Immersion Suits by model.

# CORPORATE OFFICES

Survitec Group maintains five offices in North America, providing a variety of service and distribution support to our network of customers.



## Survitec Group

1420 Wolf Creek Trail, P.O. Box 359, Sharon Center, Ohio 44274 USA  
Tel: +1 330 239 4331 | Fax: +1 330 239 3671

**Liferafts:** sharoncenter.sales@survitecgroup.com

**Spare Parts, Certificates, Servicing:** sharoncenter.service@survitecgroup.com

**Technical Services:** sharoncenter.technical@survitecgroup.com



## Survitec Group

1689 Cliveden Avenue, Delta, British Columbia, V3M 6V5 Canada  
Toll-free: +1 800 931 3221 | Tel: +1 604 278 3221 | Fax: +1 604 278 7812

**Liferafts, Spare Parts, Certificates:** vancouver.sales@survitecgroup.com

**Servicing:** vancouver.service@survitecgroup.com

**Liferaft Technical And Training:** vancouver.technical@survitecgroup.com



## Survitec Group

11070 Cabot Commerce Circle, Building 3, Suite 100, Jacksonville, Florida, 32226 USA  
Tel: +1 904 562 5900 | Fax: +1 904 562 5901

**Account Services:** jacksonville.sales@survitecgroup.com

**Servicing:** jacksonville.service@survitecgroup.com

**Technical Services:** jacksonville.technical@survitecgroup.com



## Survitec Group

1640-B Brittmoore Road, Houston, Texas, 77043 USA  
Tel: +1 713 973 8777 | Fax: +1 713 973 8781

**Sales:** houston.sales@survitecgroup.com

**Engineering:** houston.engineering@survitecgroup.com



## Survitec Group

9110 Northwest 105th Way, Medley, Florida, 33178 USA  
Tel: +1 786 476 2605 | Fax: +1 786 476 2606

**Account Services:** jacksonville.sales@survitecgroup.com

**Servicing:** miami.service@survitecgroup.com

**Technical Services:** jacksonville.technical@survitecgroup.com



ELLIOT

RFD 

CREWSAVER

PRODUCT BRANDS AT LOCATION 

PALFINGER  
NED-DECK FAST RSQ

BRUDE RFD

PRODUCT BRANDS AT LOCATION 

SURVITEC  ZODIAC  
SOLAS LIFERAFTS 

DBC

PRODUCT BRANDS AT LOCATION 

 SURVITEC SURVIVAL PRODUCTS

 NEWWAVE LIFERAFTS

 IMPERIAL

 Crewsaver®  
Safer By Design

PainsWesséx

 DANIAMANT  
mcmurdo  
safety for professionals

Electric Fuel kannad marine

 YAK  fast FIND

survitecgroup

 SGMI

# SURVITEC GROUP ACROSS THE WORLD

A STRONG PARTNERSHIP  
WITH OVER 900  
DISTRIBUTORS AND  
RETAIL DEALERS  
IN NORTH AMERICA

**NORTH  
AMERICA**

78

**SOUTH  
AMERICA**

41

**AFRICA**

52





# A GLOBAL NETWORK OF OVER 600+ OWNED OR INDEPENDENT SERVICE STATIONS ACROSS 2000 PORTS WORLDWIDE

**INTERNATIONAL  
PRESENCE IN 96  
COUNTRIES**

**550 ACCREDITED  
SERVICE STATIONS**

**50 DISTRIBUTION  
CENTERS**

**10 WORLD-CLASS  
MANUFACTURING  
FACILITIES**

**12 OFFSHORE  
SUPPORT  
LOCATIONS**

**2000 EMPLOYEES**

## EUROPE

285

## ASIA

85

## OCEANIA

38

## MIDDLE EAST

21



# GLOBAL LIFERAFT LEASE

## A FLEXIBLE SOLUTION-BASED SERVICE FOR THE SUPPLY & SERVICE OF LIFERAFTS

The Global Services Liferaft Lease program allows a customer to choose between liferaft exchange, liferaft lease or fully managed service... enjoying both immediate and long-term benefits. By leveraging the largest service network of any liferaft manufacturer in the world, we can deliver a simple, speedy and streamlined solution for maintaining liferafts when vessels are in port.

Liferaft Lease reduces the total cost of liferaft ownership. There is no investment required, no depreciation of assets, and the guarantee that a vessel will always be equipped with a set of fully serviced, high quality liferafts. Customers may extend the term of a contract or scale-up their requirements to include additional vessels. If a vessel is sold, our contracts provide easy exit options. Our standard contracts cover 5, 7 or 10 years, although shorter or longer terms are available.

These straightforward and fully customized programs ensure customers benefit from financial security for on-going service costs. For more information about our offering, contact the Sales Manager responsible for your territory.



### SERVICE LEASE

We will replace all existing liferafts with new standard annual service liferafts

When the lease liferafts are due for service, the same liferafts go back on board

Available at almost any port around the world

Easy contract exit options

Option to purchase the liferaft at the end of the lease term

All Survitec Group market-leading liferaft brands included



### EXCHANGE LEASE

We will replace all existing liferafts with Survitec extended (30 month) approved service liferafts

Easy contract exit option

Supports short port stays

Available at all key ports in the world

When the lease liferafts are due for service, they are replaced with a new approved set

Exchange in combination with extended service liferafts reduces the handling to the absolute minimum



# SERVICING

## THE SURVITEC SERVICE STAMP ENSURES PRODUCTS ARE FIT-FOR-PURPOSE

Survitec Group believes it takes strong partnerships with service stations to bring the highest quality, best value survival products to end user customers. When it comes to safety there is no margin for error or complacency. Servicing and maintenance at certified Service Stations throughout the world means customers have the best and most reliable commercial marine survival products available.

As well as standard liferaft servicing, we offer both major and minor repairs to rescue boats, PFDs, immersion suits and electronics. We have our own in-house cylinder bays and engineering workshops where we investigate the condition of equipment prior to carrying out any extensive repairs.

In order to provide a rapid service turnaround, service stations hold a host of components and spare parts, all of which are fully documented and traceable. Work always meets the highest standards and our technical ability is continuously upgraded with the latest equipment, facilities and training. To determine service offering and pricing, check the Survitec Group website and locate your nearest Service Station, then contact them directly by phone or email.

### SERVICING CAPABILITY

Regular servicing of Liferrafts, Marine Evacuation Systems, Personal Flotation Devices, Immersion Suits and Electronics as well as major and minor repairs when needed

Inflatable tube and glass fiber hulls repair for RIBs and rescue boats

Testing and refilling of gas cylinders

Each service certificate printed with a unique code to record where a service has been carried out

### SERVICE STATIONS

Strategically located service stations ensure minimum delay in the delivery and collection of equipment

All service stations are quality controlled and audited at least once every three years

Our service stations are required to stock a quantity of approved spare parts

Only approved and trained service engineers are authorized to carry out work

Service engineers must attend refresher courses once every three years

Training, audit and certification records are tracked through a global servicing database

Survitec Group owned stations in Vancouver, Jacksonville and Miami, servicing all Survitec Group liferaft brands



# AIR/SEA FIRE & SAFETY

AS THE FIRE SAFETY SPECIALIST, SURVITEC PROVIDES SOLUTIONS SUCH AS FIRE SUPPRESSION SYSTEMS, INSPECTION SERVICES AND SUPPLY FOR MARINE, AVIATION, COMMERCIAL AND INDUSTRIAL APPLICATIONS.



## SUPPRESSION SYSTEMS

Complete range of fire-fighting systems designed to maximize protection and minimize loss to life and property damage

Full design, installation and service

Authorized distribution and service for engineered systems by Kidde, Pyrene, Ansul, Chemetron, Stat-X and Seafire

FCO2 / Novec 1230 / FM-200

Specialized galley suppression systems

Fire trace linear detection and suppression combined

## SALES & SUPPLY

Portable and semi-portable fire extinguishers with marine brackets and cabinets

Personal rescue devices and rescue stretchers

Fire-fighting outfit, turn-out gear and extras

Fire hose, nozzles, axes and cabinets

Foam nozzels, inductors and liquids

Air breathing equipment

Wheeled units

Pyrotechnics

Smoke, heat, fire and CO2 detectors



## SERVICE

Inspection of firefighting equipment and systems in-shop or onsite

Hydrostatic testing of pressure vessels and fire extinguishers

Inspection and servicing of breathing apparatus, fire alarm and system, sprinkler system and emergency light system

Backflow and hydrant testing

Full maintenance and recharge facility in Vancouver for all fire equipment with trained and certified technicians

Manufacturer authorized clean agent facility for CO2 / Novec / FM-200

TC, DOT, Lloyds and ABS Approved

TO LEARN ABOUT ALL OF OUR SOLUTIONS FOR AIR/SEA FIRE AND SAFETY INSPECTION PLEASE MORE CONTACT US VIA EMAIL TO [VANCOUVER.FIRESAFETY@SURVITECGROUP.COM](mailto:VANCOUVER.FIRESAFETY@SURVITECGROUP.COM)



# LIFERAFTS

Choosing The Right One	101 - 102
Throw-Over Liferrafts	103 - 114
Decelerating System	115
Liferaft Container	
Roll-off Cradles	115

Davit-Launch Liferrafts	116 - 121
Coastal Liferrafts	122 - 125
IBA Liferrafts	126 - 130
Means Of Rescue	131
Liferaft Accessories	132



# CHOOSING THE RIGHT ONE: CONFIGURATION

Commercial liferafts are a highly regulated product. For clarity on any information contained within and specific information on a product/brand's applicability to your needs, please contact the appropriate technical department.

EVACUATION PRODUCT	ADVANTAGES
Liferaft	Flexible to several vessel sizes/types.
Marine Evacuation System	For evacuation of vessels with a far greater number of people, using less deck space than the equivalent quantity of liferafts. Configured for each specific vessel.

THROWOVER LIFERAFTS	DAVIT-LAUNCH LIFERAFTS	COASTAL LIFERAFTS	IBA/ORIL/PLATFORM LIFERAFTS
The standard canopied commercial liferaft with complete Solas A or B pack for use in all waters. Available in 4 - 25 person capacities.	Canopied liferaft complete with quick release girt systems and davit ring to be used in conjunction with a Davit. Can also be deployed as a throwover. Available in 12 - 25 person capacities.	Canopied liferaft designed for use in coastal waters, with limited coastal emergency pack. Available in 4-8 person capacities, packed in a low profile container or valise.	Liferaft without a canopy, designed and certified for passenger and or commercial fishing vessels operating in Protected or In-Shore waters. Small capacity available in low profile container or valise (4, 6 and 8 person capacities). Large capacities (25, 37, 50, 75 and 100 person) available in round container only.

PACK TYPE	DESCRIPTION	ADVANTAGES
Low-Profile Container	Fiber-glass rectangular cube with curved edges mounted to a metal cradle which is attached to the ship's deck.	Available in most sizes; smaller footprint on deck than a barrel or round container. Check your liferaft brand for availability.
Xtreme Container	Similar to a low-profile container but much more streamlined and compact, with vacuum-packed liferaft for greater space savings.	Available for many SurvitecZodiac liferaft sizes; smallest footprint on deck and a favorite for mega yachuts.
Round Container	Fiberglass cylinder mounted to a metal cradle which is attached to the ship's deck.	Available in almost all sizes, but larger footprint. Check your liferaft brand for availability.
Valise	Light-weight vinyl bag with closeable opening that can be hand-carried by ship personnel.	Available in 4, 6, 8 person sizes; smaller footprint than other containers and stowable in dry areas of a vessel only. Check your liferaft brand for availability.

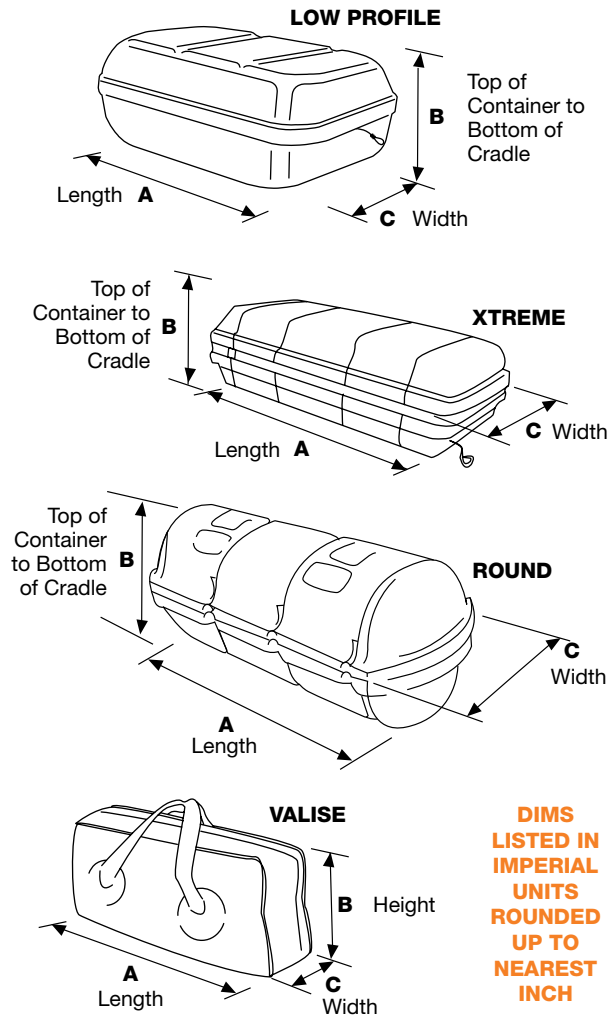

**DIMS LISTED IN IMPERIAL UNITS ROUNDED UP TO NEAREST INCH**

For further information or clarity on a particular configuration, contact the technical services department at the corporate location that supplies your brand of liferaft.

## CHOOSING THE RIGHT ONE: BRAND

BRAND	DESCRIPTION AND KEY INDUSTRIES / REGIONS SERVED
	<p>Holds USCG and SOLAS approvals.</p> <p>Important U.S. brand with a long heritage in oil, gas and other marine industries. Service stations represented world-wide.</p>
	<p>Holds USCG and TC approvals.</p> <p>Important Canadian brand with long heritage in all aspects of North American maritime industries.</p>
	<p>Holds USCG, TC, SOLAS, and MED approvals. Offered in Mk14x17 container, which fits directly into a competitor deck cradle with no modification required. For both foreign and domestic vessels. Extensive service station network. Original German brand from which many European liferafts still share roots. A top choice for many vessels world-wide.</p>
	<p>Holds USCG, TC and SOLAS approvals.</p> <p>Premiere American brand for flagged and military vessels. Strong service station presence in North America, with representation world-wide.</p>
	<p>Holds USCG and SOLAS approvals.</p> <p>Important U.S. brand with applicability in key markets including commercial fishing. Service stations represented world-wide.</p>
	<p>Holds USCG, TC, SOLAS and MED approvals.</p> <p>Preferred brand for foreign-flagged vessels across the world. Has the largest international service station network.</p>
	<p>Holds USCG and SOLAS approvals.</p> <p>One of the newest brand offerings for a wide range of commercial vessels. Service stations represented world-wide.</p>
	<p>Holds USCG, TC, SOLAS and MED approval.</p> <p>Highest quality design and workmanship. Built in France and a favorite in global marine fleets. Extensive world-wide service station coverage.</p>



# THROW-OVER LIFERAFTS

Manufactured from polyurethane (PU) coated nylon, ensuring its durability

Non-inflatable easy access boarding ramp

Fully enclosed double skinned high visibility canopy complete with SOLAS-grade reflective tape

Rafts come packed in containers with hydrostatic release unit (HRU) assembly and cradle



APPROVALS

USCG

SOLAS

MODEL / CAPACITY	CONTAINER TYPE	A X B X C DIMS	DROP HEIGHT	SOLAS PACK TYPE / WEIGHT		PRODUCT #	SG SC
MK4 4 Person	Low Profile	35" x 12" x 25"	18 Meter	A-Pack	117 Lbs.	00007221E	
		35" x 12" x 25"		B-Pack	99 Lbs.	00007228E	
MK4 6 Person	Low Profile	39" x 17" x 26"	18 Meter	A-Pack	167 Lbs.	00008407E	
		35" x 12" x 25"		B-Pack	125 Lbs.	00008413E	
	Round	50" x 24" x 19"	36 Meter	A-Pack	167 Lbs.	00008416E	
		46" x 22" x 17"		B-Pack	126 Lbs.	00008465E	
MK4 8 Person	Low Profile	39" x 17" x 26"	18 Meter	A-Pack	190 Lbs.	00009361E	
		39" x 17" x 26"		B-Pack	137 Lbs.	00009368E	
	Round	50" x 24" x 19"	36 Meter	A-Pack	176 Lbs.	00009371E	
		46" x 22" x 17"		B-Pack	126 Lbs.	00009461E	
MK4 10 Person	Round	55" x 26" x 21"	36 Meter	A-Pack	220 Lbs.	00010317E	
		50" x 24" x 19"		B-Pack	176 Lbs.	00010316E	
MK4 12 Person	Round	55" x 26" x 21"	36 Meter	A-Pack	240 Lbs.	00011511E	
		50" x 24" x 19"		B-Pack	187 Lbs.	00011542E	
MK4 16 Person	Round	61" x 26" x 21"	36 Meter	A-Pack	302 Lbs.	00041438E	
		55" x 26" x 21"		B-Pack	227 Lbs.	00041437E	
MK4 20 Person	Round	64" x 28" x 23"	36 Meter	A-Pack	348 Lbs.	00012548E	
		61" x 26" x 21"		B-Pack	240 Lbs.	00012587E	
MK4 25 Person	Round	64" x 28" x 23"	36 Meter	A-Pack	392 Lbs.	00013576E	
		61" x 26" x 21"		B-Pack	282 Lbs.	00013657E	

THE 6-25 PERSON ELLIOT LIFERAFT PACKED IN A ROUND CONTAINER IS AVAILABLE IN 18 AND 36 METER DROP HEIGHTS. THE 25 PERSON IS AVAILABLE IN 36 AND 46 METER DROP HEIGHTS. TO ENSURE YOU ARE PURCHASING THE CORRECT LIFERAFT FOR YOUR APPLICATION, PLEASE SPEAK TO YOUR SALES COORDINATOR OR MANAGER WHEN ORDERING.



# THROW-OVER LIFERAFTS

## CREWSAVER

**APPROVALS**



Manufactured from polyurethane (PU) coated nylon, ensuring its durability

Non-inflatable easy access boarding ramp

Fully enclosed double skinned high visibility canopy complete with SOLAS-grade reflective tape

Rafts come packed in containers with hydrostatic release unit (HRU) assembly and cradle

MODEL / CAPACITY	CONTAINER TYPE	A X B X C DIMS	DROP HEIGHT	SOLAS PACK TYPE / WEIGHT		PRODUCT #	SG SC
MK4 4 Person	Low Profile	35" x 12" x 25"	18 Meter	A-Pack	117 Lbs.	00007221C	
		35" x 12" x 25"		B-Pack	99 Lbs.	00007228C	
MK4 6 Person	Low Profile	39" x 17" x 26"	18 Meter	A-Pack	167 Lbs.	00008407C	
		35" x 12" x 25"		B-Pack	125 Lbs.	00008413C	
	Round	50" x 24" x 19"	36 Meter	A-Pack	167 Lbs.	00008416C	
		46" x 22" x 17"		B-Pack	126 Lbs.	00008465C	
MK4 8 Person	Low Profile	39" x 17" x 26"	18 Meter	A-Pack	190 Lbs.	00009361C	
		39" x 17" x 26"		B-Pack	137 Lbs.	00009368C	
	Round	50" x 24" x 19"	36 Meter	A-Pack	176 Lbs.	00009371C	
		46" x 22" x 17"		B-Pack	126 Lbs.	00009461C	
MK4 10 Person	Round	55" x 26" x 21"	36 Meter	A-Pack	220 Lbs.	00010317C	
		50" x 24" x 19"		B-Pack	176 Lbs.	00010316C	
MK4 12 Person	Round	55" x 26" x 21"	36 Meter	A-Pack	240 Lbs.	00011511C	
		50" x 24" x 19"		B-Pack	187 Lbs.	00011542C	
MK4 16 Person	Round	61" x 26" x 21"	36 Meter	A-Pack	302 Lbs.	00041438C	
		55" x 26" x 21"		B-Pack	227 Lbs.	00041437C	
MK4 20 Person	Round	64" x 28" x 23"	36 Meter	A-Pack	348 Lbs.	00012548C	
		61" x 26" x 21"		B-Pack	240 Lbs.	00012587C	
MK4 25 Person	Round	64" x 28" x 23"	36 Meter	A-Pack	392 Lbs.	00013576C	
		61" x 26" x 21"		B-Pack	282 Lbs.	00013657C	

THE 6-25 PERSON CREWSAVER LIFERAFT PACKED IN A ROUND CONTAINER IS AVAILABLE IN 18 AND 36 METER DROP HEIGHTS. THE 25 PERSON IS AVAILABLE IN 36 AND 46 METER DROP HEIGHTS. TO ENSURE YOU ARE PURCHASING THE CORRECT LIFERAFT FOR YOUR APPLICATION, PLEASE SPEAK TO YOUR SALES COORDINATOR OR MANAGER WHEN ORDERING.



# THROW-OVER LIFERAFTS

Manufactured from polyurethane (PU) coated nylon, ensuring its durability

Fully enclosed double skinned high visibility canopy complete with SOLAS-grade reflective tape

Non-inflatable easy access boarding ramp

High volume water pockets to ensure maximum stability when inflating

Stowed in lightweight streamlined GRP containers enabling maximum deck space utilisation

Rafts come packed in containers with hydrostatic release unit (HRU) assembly and cradle

Surviva liferafts are manufactured to the highest quality standards and stowed in a variety of containers designed to suit most deck spaces. All configurations of these throw-over liferafts are fully approved, ensuring suitability for vessels throughout the world.



MODEL / CAPACITY	CONTAINER TYPE	A X B X C DIMS	DROP HEIGHT	SOLAS PACK TYPE / WEIGHT	PRODUCT #	SGSC
Surviva 4 Person	Low Profile	35" x 12" x 25"	18 Meter	A-Pack 117 Lbs.	00007259	
		35" x 12" x 25"		B-Pack 99 Lbs.	00007228	
Surviva 6 Person	Low Profile	39" x 17" x 26"	18 Meter	A-Pack 167 Lbs.	00008524	
		35" x 12" x 25"		B-Pack 125 Lbs.	Call	
	Round	50" x 24" x 19"	36 Meter	A-Pack 167 Lbs.	00008359	
		46" x 22" x 17"		B-Pack 126 Lbs.	Call	
Surviva 8 Person	Low Profile	39" x 17" x 26"	18 Meter	A-Pack 190 Lbs.	00009454	
		39" x 17" x 26"		B-Pack 137 Lbs.	Call	
	Round	50" x 24" x 19"	36 Meter	A-Pack 176 Lbs.	00009435	
		46" x 22" x 17"		B-Pack 126 Lbs.	Call	
Surviva 10 Person	Round	55" x 26" x 21"	36 Meter	A-Pack 220 Lbs.	00010339	
		50" x 24" x 19"		B-Pack 176 Lbs.	Call	
Surviva 12 Person	Round	55" x 26" x 21"	36 Meter	A-Pack 240 Lbs.	00011605	
		50" x 24" x 19"		B-Pack 187 Lbs.	Call	
Surviva 16 Person	Round	61" x 26" x 21"	36 Meter	A-Pack 302 Lbs.	00041406	
		55" x 26" x 21"		B-Pack 227 Lbs.	Call	
Surviva 20 Person	Round	64" x 28" x 23"	36 Meter	A-Pack 348 Lbs.	00012551	
		61" x 26" x 21"		B-Pack 240 Lbs.	Call	
Surviva 25 Person	Round	64" x 28" x 23"	36 Meter	A-Pack 392 Lbs.	00013563	
		61" x 26" x 21"		B-Pack 282 Lbs.	Call	

THE 6-25 PERSON RFD LIFERAFT PACKED IN A ROUND CONTAINER IS AVAILABLE IN 18 AND 36 METER DROP HEIGHTS. THE 25 PERSON IS AVAILABLE IN 36 AND 46 METER DROP HEIGHTS. TO ENSURE YOU ARE PURCHASING THE CORRECT LIFERAFT FOR YOUR APPLICATION, PLEASE SPEAK TO YOUR SALES COORDINATOR OR MANAGER WHEN ORDERING.



# THROW-OVER LIFERAFTS

The LR07 is the latest MED approved liferaft from DSB which offers a quality product that is durable and cost effective. Stability, insulation, visibility and ease of stowage all feature highly in the design of these liferafts.

Manufactured from polyurethane (PU) coated nylon, ensuring its durability

Fully enclosed double skinned high visibility canopy complete with SOLAS-grade reflective tape

Semi-rigid easy access boarding ramp

Large water pockets to ensure maximum stability when inflating

Fully insulated floor to ensure maximum thermal protection



APPROVALS



USCG MODEL / CAPACITY	CONTAINER TYPE	A X B* X C DIMS	SOLAS PACK TYPE / WEIGHT	PRODUCT #	SGSC
LR07 6 Person	Round	50" x 19" x 19"	A-Pack 168 Lbs.	00008353	
		41" x 24" x 24"	B-Pack 139 Lbs.	Call	
LR07 8 Person	Round	50" x 19" x 19"	A-Pack 176 Lbs.	00009458	
		41" x 24" x 24"	B-Pack 139 Lbs.	Call	
LR07 12 Person	Round	50" x 19" x 19"	A-Pack 238 Lbs.	00011628	
		46" x 23" x 23"	B-Pack 187 Lbs.	Call	
LR07 16 Person	Round	52" x 27" x 27"	A-Pack 306 Lbs.	00041552	
		46" x 23" x 23"	B-Pack 223 Lbs.	Call	
LR07 20 Person	Round	52" x 27" x 27"	A-Pack 353 Lbs.	00012671	
		46" x 23" x 23"	B-Pack 234 Lbs.	Call	
LR07 25 Person	Round	52" x 27" x 27"	A-Pack 397 Lbs.	00013757	
		52" x 27" x 27"	B-Pack 298 Lbs.	Call	

MED MODEL / CAPACITY	CONTAINER TYPE	A X B* X C DIMS	SOLAS PACK TYPE / WEIGHT	PRODUCT #	SGSC
LR07 6 Person	Round	50" x 19" x 19"	A-Pack 168 Lbs.	00008498	
		41" x 24" x 24"	B-Pack 139 Lbs.	Call	
LR07 8 Person	Round	50" x 19" x 19"	A-Pack 176 Lbs.	00009433	
		41" x 24" x 24"	B-Pack 139 Lbs.	Call	
LR07 10 Person	Round	50" x 19" x 19"	A-Pack 218 Lbs.	00010367	
		46" x 23" x 23"	B-Pack 176 Lbs.	Call	
LR07 12 Person	Round	50" x 19" x 19"	A-Pack 238 Lbs.	00011585	
		46" x 23" x 23"	B-Pack 187 Lbs.	Call	
LR07 16 Person	Round	52" x 27" x 27"	A-Pack 306 Lbs.	00041514	
		46" x 23" x 23"	B-Pack 223 Lbs.	Call	
LR07 20 Person	Round	52" x 27" x 27"	A-Pack 353 Lbs.	00012637	
		46" x 23" x 23"	B-Pack 234 Lbs.	Call	
LR07 25 Person	Round	52" x 27" x 27"	A-Pack 397 Lbs.	00013684	
		52" x 27" x 27"	B-Pack 298 Lbs.	Call	

\*B DIMENSION FOR DSB LIFERAFT CONTAINERS ARE NOT INCLUSIVE OF CRADLE. TO ENSURE YOU ARE PURCHASING THE CORRECT LIFERAFT FOR YOUR APPLICATION, PLEASE SPEAK TO YOUR SALES COORDINATOR OR MANAGER WHEN ORDERING.



# THROW-OVER LIFERAFTS

SSP OceanMaster liferafts are renowned for uncompromising quality and design sophistication. In addition to meeting the requirements of the International Convention of the Safety of Life at Sea (SOLAS) 1996, as amended (except for 4-person model), the OceanMaster is manufactured to NATO AQAP 1 quality standards and holds approvals from most major international marine authorities, including the United States Coast Guard and UK Department of Trade. Today, there are thousands of OceanMaster liferafts in service on commercial, naval and fishing vessels worldwide.

Manufactured from polyurethane (PU) coated nylon, ensuring its durability

Fully enclosed double skinned high visibility canopy complete with SOLAS-grade reflective tape

Non-inflatable easy access boarding ramp

All models are SOLAS Approved (except for 4-person model) and come with SOLAS "A" Equipment Packs unless otherwise requested

Rafts come packed in containers with hydrostatic release unit (HRU) assembly and cradle



**OCEANMASTER, 10-25 PERSON**



**SOLAS "A" EQUIPMENT PACK**

- |  |  |
|--|--|
| 6 USCG/SOLAS Hand Flares                                   | Repair Kit                                     |
| 4 USCG/SOLAS Parachute Flares                              | Signal whistle                                 |
| 2 USCG/SOLAS Smoke Signals                                 | Repair plugs                                   |
| 1 Topping-Up Air Pump                                      | 1 Drinking Cup                                 |
| 1 Sea Anchor with SS swivel                                | Seasick Tablets                                |
| Throwing quoit w/ 100 ft. line                             | 1 Flashlight, Spare Bulb and Extra batteries   |
| Thermal Protective Aids                                    | 1 Signal Mirror                                |
| Sea Sickness Bags  | 1 First Aid Kit                                |
| Survival Instructions                                      | 1 Fishing Kit                                  |
| 1 Spare sea Anchor   | 3 Can Openers                                  |
| 2400 Cal. Food Rations                                     | 1 Floating Knife                               |
| 4.2 oz. water packs  | 1 Lock back knife (on 16-25 person rafts only) |
| Bailer (1 for 4-12 person rafts; 2 for 16-25 person rafts) |  |
| 2 Paddles  |  |
| 2 Sponges  |  |



**OCEANMASTER, 4-8 PERSON**



**LOW PROFILE CONTAINER ON CRADLE**



**ROUND CONTAINER ON CRADLE**

18 METER HIGH STOWAGE MODEL / CAPACITY	CONTAINER TYPE	A X B X C DIMENSIONS	SOLAS PACK TYPE / WEIGHT		PRODUCT #	SG JV
OceanMaster 4 Person	Low Profile	34" x 25" x 13.5"	A-Pack	119 Lbs.	50-R/R-4M-O	
		34" x 25" x 13.5"	B-Pack	96 Lbs.	50-R/R-4M-L	
OceanMaster 6 Person	Low Profile	38" x 26.5" x 16.5"	A-Pack	162 Lbs.	50-R/R-6M-A-L	
		38" x 26.5" x 16.5"	B-Pack	131 Lbs.	50-R/R-6M-B-L	
	Round	50" x 21" x 19"	A-Pack	166 Lbs.	50-R/R-6M-A-R	
		46" x 22" x 17"	B-Pack	126 Lbs.	50-R/R-6M-B-R	
OceanMaster 8 Person	Low Profile	38" x 26.5" x 16.5"	A-Pack	174 Lbs.	50-R/R-8M-A-L	
		38" x 26.5" x 16.5"	B-Pack	132 Lbs.	50-R/R-8M-B-L	
	Round	50" x 21" x 19"	A-Pack	178 Lbs.	50-R/R-8M-A-R	
		46" x 22" x 17"	B-Pack	126 Lbs.	50-R/R-8M-B-R	
OceanMaster 10 Person	Round	55" x 23" x 21"	A-Pack	217 Lbs.	50-R/R-10M-A	
		50" x 24" x 19"	B-Pack	176 Lbs.	50-R/R-10M-B	
OceanMaster 12 Person	Round	55" x 23" x 21"	A-Pack	230 Lbs.	50-R/R-12M-A	
		50" x 24" x 19"	B-Pack	187 Lbs.	50-R/R-12M-B	
OceanMaster 16 Person	Round	61" x 23" x 21"	A-Pack	286 Lbs.	50-R/R-16M-A	
		55" x 26" x 21"	B-Pack	227 Lbs.	50-R/R-16M-B	
OceanMaster 20 Person	Round	64" x 24.5" x 23"	A-Pack	328 Lbs.	50-R/R-20M-A	
		61" x 26" x 21"	B-Pack	240 Lbs.	50-R/R-20M-B	
OceanMaster 25 Person	Round	64" x 24.5" x 23"	A-Pack	370 Lbs.	50-R/R-25M-A	
		61" x 26" x 21"	B-Pack	282 Lbs.	50-R/R-25M-B	

*28/36 METER HIGH STOWAGE HIGH-DROP MODEL / CAPACITY	CONTAINER TYPE	A X B X C DIMENSIONS	SOLAS PACK TYPE / WEIGHT		PRODUCT #	SG JV
OceanMaster 6 Person	Round	50" x 21" x 19"	A-Pack	166 Lbs.	50-R/R-6M-A-HD	
		46" x 22" x 17"	B-Pack	126 Lbs.	50-R/R-6M-B-HD	
OceanMaster 8 Person	Round	50" x 21" x 19"	A-Pack	178 Lbs.	50-R/R-8M-A-HD	
		46" x 22" x 17"	B-Pack	126 Lbs.	50-R/R-8M-B-HD	
OceanMaster 10 Person	Round	55" x 23" x 21"	A-Pack	217 Lbs.	50-R/R-10M-A-HD	
		50" x 24" x 19"	B-Pack	176 Lbs.	50-R/R-10M-B-HD	
OceanMaster 12 Person	Round	55" x 23" x 21"	A-Pack	230 Lbs.	50-R/R-12M-A-HD	
		55" x 26" x 21"	B-Pack	187 Lbs.	50-R/R-12M-B-HD	
OceanMaster 16 Person	Round	61" x 23" x 21"	A-Pack	286 Lbs.	50-R/R-16M-A-HD	
		61" x 26" x 21"	B-Pack	227 Lbs.	50-R/R-16M-B-HD	
OceanMaster 20 Person	Round	64" x 24.5" x 23"	A-Pack	328 Lbs.	50-R/R-20M-A-HD	
		64" x 28" x 23"	B-Pack	240 Lbs.	50-R/R-20M-B-HD	
OceanMaster 25 Person	Round	64" x 24.5" x 23"	A-Pack	370 Lbs.	50-R/R-25M-A-HD	
		64" x 28" x 23"	B-Pack	282 Lbs.	50-R/R-25M-B-HD	

\*ORDERS FOR HIGH-DROP MODELS MUST LIST DESIRED STOWAGE HEIGHT OF 28 OR 36 METERS



# THROW-OVER LIFERAFTS

New Wave Guardian liferafts are renowned for uncompromising quality and design sophistication. In addition to meeting the requirements of the International Convention of the Safety of Life at Sea (SOLAS) 1996, as amended (except for 4-person model), the Guardian is manufactured to NATO AQAP 1 quality standards and holds approvals from most major international marine authorities, including the United States Coast Guard and UK Department of Trade.

Manufactured from polyurethane (PU) coated nylon, ensuring its durability

Fully enclosed double skinned high visibility canopy complete with SOLAS-grade reflective tape

Non-inflatable easy access boarding ramp

All models are SOLAS Approved (except for 4-person model) and come with SOLAS "A" Equipment Packs unless otherwise requested

Rafts come packed in containers with hydrostatic release unit (HRU) assembly and cradle



**GUARDIAN, 10-25 PERSON**



## SOLAS "A" EQUIPMENT PACK

- |  |  |
|--|--|
| 6 USCG/SOLAS Hand Flares                                   | Repair Kit                                     |
| 4 USCG/SOLAS Parachute Flares                              | Signal whistle                                 |
| 2 USCG/SOLAS Smoke Signals                                 | Repair plugs                                   |
| 1 Topping-Up Air Pump                                      | 1 Drinking Cup                                 |
| 1 Sea Anchor with SS swivel                                | Seasick Tablets                                |
| Throwing quoit w/ 100 ft. line                             | 1 Flashlight, Spare Bulb and Extra batteries   |
| Thermal Protective Aids                                    | 1 Signal Mirror                                |
| Sea Sickness Bags  | 1 First Aid Kit                                |
| Survival Instructions                                      | 1 Fishing Kit                                  |
| 1 Spare sea Anchor   | 3 Can Openers                                  |
| 2400 Cal. Food Rations                                     | 1 Floating Knife                               |
| 4.2 oz. water packs  | 1 Lock back knife (on 16-25 person rafts only) |
| Bailer (1 for 4-12 person rafts; 2 for 16-25 person rafts) |  |
| 2 Paddles  |  |
| 2 Sponges  |  |



**GUARDIAN, 4-8 PERSON**



**LOW PROFILE  
CONTAINER ON CRADLE**



**ROUND  
CONTAINER ON CRADLE**

18 METER HIGH STOWAGE MODEL / CAPACITY	CONTAINER TYPE	A X B X C DIMENSIONS	SOLAS PACK TYPE / WEIGHT		PRODUCT #	SG JV
Guardian 4 Person	Low Profile	34" x 25" x 13.5"	A-Pack	119 Lbs.	50-NWG4-A-LP	
		34" x 25" x 13.5"	B-Pack	96 Lbs.	50-NWG4-B-LP	
Guardian 6 Person	Low Profile	38" x 26.5" x 16.5"	A-Pack	162 Lbs.	50-NWG6-A-LP	
		38" x 26.5" x 16.5"	B-Pack	131 Lbs.	50-NWG6-B-LP	
	Round	50" x 21" x 19"	A-Pack	166 Lbs.	50-NWG6-A-R	
		46" x 22" x 17"	B-Pack	126 Lbs.	50-NWG6-B-R	
Guardian 8 Person	Low Profile	38" x 26.5" x 16.5"	A-Pack	174 Lbs.	50-NWG8-A-LP	
		38" x 26.5" x 16.5"	B-Pack	132 Lbs.	50-NWG8-B-LP	
	Round	50" x 21" x 19"	A-Pack	178 Lbs.	50-NWG8-A-R	
		46" x 22" x 17"	B-Pack	126 Lbs.	50-NWG8-B-R	
Guardian 10 Person	Round	55" x 23" x 21"	A-Pack	217 Lbs.	50-NWG10-A-R	
		50" x 24" x 19"	B-Pack	176 Lbs.	50-NWG10-B-R	
Guardian 12 Person	Round	55" x 23" x 21"	A-Pack	230 Lbs.	50-NWG12-A-R	
		50" x 24" x 19"	B-Pack	187 Lbs.	50-NWG12-B-R	
Guardian 16 Person	Round	61" x 23" x 21"	A-Pack	286 Lbs.	50-NWG16-A-R	
		55" x 26" x 21"	B-Pack	227 Lbs.	50-NWG16-B-R	
Guardian 20 Person	Round	64" x 24.5" x 23"	A-Pack	328 Lbs.	50-NWG20-A-R	
		61" x 26" x 21"	B-Pack	240 Lbs.	50-NWG20-B-R	
Guardian 25 Person	Round	64" x 24.5" x 23"	A-Pack	370 Lbs.	50-NWG25-A-R	
		61" x 26" x 21"	B-Pack	282 Lbs.	50-NWG25-B-R	

*28/36 METER HIGH STOWAGE HIGH-DROP MODEL / CAPACITY	CONTAINER TYPE	A X B X C DIMENSIONS	SOLAS PACK TYPE / WEIGHT		PRODUCT #	SG JV
Guardian 6 Person	Round	50" x 21" x 19"	A-Pack	166 Lbs.	50-NWG6-A-RHD	
		46" x 22" x 17"	B-Pack	126 Lbs.	50-NWG6-B-RHD	
Guardian 8 Person	Round	50" x 21" x 19"	A-Pack	178 Lbs.	50-NWG8-A-RHD	
		46" x 22" x 17"	B-Pack	126 Lbs.	50-NWG8-B-RHD	
Guardian 10 Person	Round	55" x 23" x 21"	A-Pack	217 Lbs.	50-NWG10-A-RHD	
		50" x 24" x 19"	B-Pack	176 Lbs.	50-NWG10-B-RHD	
Guardian 12 Person	Round	55" x 23" x 21"	A-Pack	230 Lbs.	50-NWG12-A-RHD	
		55" x 26" x 21"	B-Pack	187 Lbs.	50-NWG12-B-RHD	
Guardian 16 Person	Round	61" x 23" x 21"	A-Pack	286 Lbs.	50-NWG16-A-RHD	
		61" x 26" x 21"	B-Pack	227 Lbs.	50-NWG16-B-RHD	
Guardian 20 Person	Round	64" x 24.5" x 23"	A-Pack	328 Lbs.	50-NWG20-A-RHD	
		64" x 28" x 23"	B-Pack	240 Lbs.	50-NWG20-B-RHD	
Guardian 25 Person	Round	64" x 24.5" x 23"	A-Pack	370 Lbs.	50-NWG25-A-RHD	
		64" x 28" x 23"	B-Pack	282 Lbs.	50-NWG25-B-RHD	

\*ORDERS FOR HIGH-DROP MODELS MUST LIST DESIRED STOWAGE HEIGHT OF 28 OR 36 METERS



# THROW-OVER LIFERAFTS

Manufactured from durable polyurethane (PU) coated fabric  
 Uses Thermobonding™ hot assembly technique  
 Easy access boarding ramp  
 Rafts come packed in containers with hydrostatic release unit (HRU) assembly, lashing and cradle for U.S. product only

Manufactured with a durable polyurethane coated fabric, all SurvitecZodiac throw-over liferafts are assembled using the advanced SurvitecZodiac hot assembly technique, Thermobonding™.

The fabric's chemical nature and the Thermobonding™ process make these throw-over liferafts resilient in the Marine environment, enhancing the liferaft's extreme strength and safety when loaded, an essential factor for this type of liferaft.

Due to the fabric weight and structure, SurvitecZodiac throw-over liferafts are easy to service and fit in light, small sized but strong, glass reinforced plastic containers. SurvitecZodiac throw-over liferafts can be dropped from up to 36 meters (may vary depending on the size of the liferaft).

Equipment packs are sealed in strong watertight bags, secured to the internal safety line of the liferafts.

## SURVITECZODIAC THROW-OVER LIFERAFTS ARE AVAILABLE IN SIZES FROM 4 - 150 PERSONS



## SURVITECZODIAC XTREM THROW-OVER LIFERAFTS

SurvitecZodiac Xtrem is an innovative solution for maximizing deck space on vessels. These are standard SurvitecZodiac throwover liferafts vacuum-packed into an Xtrem container, which provides a 25-35% smaller footprint than any other conventionally packed low profile container in the market.

### LOW PROFILE CONTAINER



### XTREM CONTAINER



### EPE THROW-OVER LIFERAFTS

30-month extended service interval throw-over liferafts with EC/MED, SOLAS, TC only approvals are available. Contact us for additional information or to order.

CAPACITY	CONTAINER TYPE	TC MODEL PRODUCT #	SGVN
4 Person	Low Profile	DRZ31111	
6 Person	Round	DRZ3112	
	Low Profile	DRZ31170	
8 Person	Round	DRZ3113	
	Low Profile	DRZ31171	
10 Person	Round	DRZ31160	
	Low Profile	DRZ31172	
12 Person	Round	DRZ31195	
16 Person	Round	DRZ31016	
20 Person	Round	DRZ31162	
25 Person	Round	DRZ31206	

### ROUND CONTAINER



### COMPARISON TO STANDARD LOW PROFILE CONTAINER





FOR PROPER PACKING, PLEASE INDICATE LAUNCH HEIGHT FROM VESSEL



CAPACITY	CONTAINER TYPE	A X B X C DIMS	SOLAS PACK TYPE / WEIGHT	USCG MODEL PRODUCT #	TC MODEL PRODUCT #	
4 Person	Low Profile	N133	37" x 23" x 15" (924x574x359mm)	A-Pack 126 Lbs. (57 kg)	DRZ0401	DRZ0908
			B-Pack 102 Lbs. (46 kg)	DRZ0402	DRZ0909	
6 Person	Round	N12	46" x 22" x 21" (1160x513x560mm)	A-Pack 150 Lbs. (68 kg)	DRZ0850	DRZ0910
			B-Pack 115 Lbs. (52 kg)	DRZ0857	DRZ0911	
	Low Profile	N134	38" x 24" x 15" (965x596x380mm)	A-Pack 146 Lbs. (66 kg)	DRZ4700	DRZ31005
		N133	37" x 23" x 15" (924x574x359mm)	B-Pack 113 Lbs. (51 kg)	DRZ4701	DRZ31006
	Xtrem	N137H	31" x 14" x 22" (790x340x555mm)	A-Pack 142 Lbs. (64 kg)	DRZ31141	DRZ31173
N137	31" x 11" x 22" (790x270x555mm)	B-Pack 106 Lbs. (48 kg)	Call	Call		
8 Person	Round	N12	46" x 22" x 21" (1160x513x560mm)	A-Pack 170 Lbs. (77 kg)	DRZ0851	DRZ0912
			B-Pack 128 Lbs. (58 kg)	DRZ0858	DRZ0913	
	Low Profile	N135	43" x 27" x 16" (1088x666x389mm)	A-Pack 175 Lbs. (79 kg)	DRZ4702	DRZ31007
		N134	78" x 24" x 15" (965x596x380mm)	B-Pack 126 Lbs. (57 kg)	DRZ4703	DRZ31008
	Xtrem	N138H	34" x 14" x 23" (840x340x570mm)	A-Pack 164 Lbs. (74 kg)	DRZ31142	DRZ31174
		N138	34" x 12" x 23" (840x294x570mm)	B-Pack 126 Lbs. (57 kg)	DRZ31289	Call
10 Person	Round	N13	52" x 24" x 25" (1275x590x610mm)	A-Pack 203 Lbs. (92 kg)	DRZ0852	DRZ0914
			B-Pack 139 Lbs. (63 kg)	DRZ0859	DRZ0915	
	Low Profile	N135	43" x 27" x 16" (1088x666x389mm)	A-Pack 199 Lbs. (90 kg)	DRZ4704	DRZ31009
			B-Pack 144 Lbs. (65 kg)	DRZ4705	DRZ31010	
	Xtrem	N139H	37" x 14" x 26" (940x344x640mm)	A-Pack 192 Lbs. (87 kg)	DRZ31143	DRZ31175
		N139	37" x 13" x 26" (940x314x640mm)	B-Pack 139 Lbs. (63 kg)	Call	Call
12 Person	Round	N13	52" x 24" x 25" (1275x590x610mm)	A-Pack 223 Lbs. (101 kg)	DRZ31189	DRZ31193
			B-Pack 155 Lbs. (70 kg)	DRZ31232	DRZ31227	
	Low Profile	N135	43" x 27" x 16" (1088x666x389mm)	A-Pack 221 Lbs. (100 kg)	DRZ31190	DRZ31228
			N134	38" x 24" x 15" (965x596x380mm)	B-Pack 153 Lbs. (69 kg)	DRZ31233
	Xtrem	N139H	37" x 14" x 26" (940x344x640mm)	A-Pack 212 Lbs. (96 kg)	DRZ31192	DRZ31196
		N139	37" x 13" x 26" (940x314x640mm)	B-Pack 147 Lbs. (67 kg)	Call	Call
16 Person	Round	N14	52" x 25" x 27" (1275x615x680mm)	A-Pack 285 Lbs. (129 kg)	DRZ0854	DRZ0918
			B-Pack 201 Lbs. (91 kg)	DRZ0861	DRZ0919	
	Low Profile	N136H	46" x 30" x 20" (1160x752x505mm)	A-Pack 278 Lbs. (126 kg)	DRZ4708	DRZ31013
			N136	46" x 30" x 18" (1160x752x445mm)	B-Pack 192 Lbs. (87 kg)	DRZ4709
	Xtrem	N140H	44" x 15" x 26" (1100x370x650mm)	A-Pack 269 Lbs. (122 kg)	DRZ31145	DRZ31177
		N140	44" x 14" x 26" (1100x340x650mm)	B-Pack 190 Lbs. (86 kg)	Call	Call
20 Person	Round	N15	52" x 30" x 32" (1275x740x800mm)	A-Pack 331 Lbs. (150 kg)	DRZ0855	DRZ0920
			B-Pack 217 Lbs. (98 kg)	DRZ0862	DRZ0921	
	Low Profile	N136H	46" x 30" x 20" (1160x752x505mm)	A-Pack 318 Lbs. (144 kg)	DRZ31306	Call
			N136	46" x 30" x 18" (1160x752x445mm)	B-Pack 211 Lbs. (95,5 kg)	Call
25 Person	Round	N15	52" x 30" x 32" (1275x740x800mm)	A-Pack 382 Lbs. (173 kg)	DRZ0856	DRZ0922
			N14	52" x 25" x 27" (1275x615x680mm)	B-Pack 250 Lbs. (113 kg)	DRZ0863
50 Person	Round	N20	62" x 38" x 38" (1560x960x952mm)	A-Pack 814 Lbs. (369 kg)	DRZ0605P/S	DRZ0949
			N18	62" x 33" x 34" (1560x835x852mm)	B-Pack 514 Lbs. (233 kg)	DRZ0606P/S
100 Person	Round	N29	77" x 39" x 42" (1950x975x1050mm)	A-Pack 1235 Lbs. (560 kg)	Call	Call
			N25	68" x 40" x 42" (1725x1000x1050mm)	B-Pack 948 Lbs. (430 kg)	Call
150 Person	Round	N19	76" x 45" x 46" (1930x1120x1150mm)	A-Pack 1081 Lbs. (490 kg)	Call	Call

PLEASE VISIT [WWW.SURVITECZODIAC.COM](http://WWW.SURVITECZODIAC.COM) FOR DATASHEETS AND CERTIFICATIONS AVAILABLE ONLINE.



# SELF-RIGHTING THROW-OVER LIFERAFTS

Utilizing the same manufacturing quality as the standard SurvitecZodiac throw-over liferafts, the self-righting throw-over models integrate a unique self-righting design. The design causes the liferaft to rotate into the correct position for boarding, regardless of how it inflates in the water after deployment from its container.

Manufactured from durable polyurethane (PU) coated fabric

Uses Thermobonding™ hot assembly technique

Easy access boarding ramp

Rafts come packed in containers with hydrostatic release unit (HRU) assembly, lashing and cradle for U.S. product only



FOR PROPER PACKING, PLEASE INDICATE VESSEL LAUNCH HEIGHT WHEN ORDERING



CAPACITY	CONTAINER TYPE	A X B X C DIMS	SOLAS PACK TYPE / WEIGHT	USCG MODEL PRODUCT #	TC MODEL PRODUCT #
6 Person	Round	N12	46" x 22" x 23" (1160x513x560mm)	A-Pack 159 Lbs. (72 kg)	Call
		N12	46" x 22" x 23" (1160x513x560mm)	B-Pack 128 Lbs. (58 kg)	Call
	Low Profile	N133	37" x 15" x 23" (924x359x574mm)	A-Pack 159 Lbs. (72 kg)	Call
		N132	36" x 14" x 21" (890x333x520mm)	B-Pack 122 Lbs. (55 kg)	Call
8 Person	Round	N12	46" x 22" x 23" (1160x513x560mm)	A-Pack 195 Lbs. (88 kg)	Call
		N12	46" x 22" x 23" (1160x513x560mm)	B-Pack 153 Lbs. (69 kg)	Call
12 Person	Round	N13	52" x 24" x 25" (1275x590x610mm)	A-Pack 252 Lbs. (114 kg)	N/A
		N12	46" x 22" x 23" (1160x513x560mm)	B-Pack 181 Lbs. (82 kg)	N/A
37 Person	Round	N17	60" x 38" x 38" (1500x945x950mm)	A-Pack 688 Lbs. (312 kg)	N/A
		N16	58" x 30" x 32" (1450x740x800mm)	B-Pack 490 Lbs. (222 kg)	N/A
50 Person	Round	N20	62" x 38" x 38" (1560x960x952mm)	A-Pack 794 Lbs. (360 kg)	Call
		N18	62" x 33" x 34" (1560x835x852mm)	B-Pack 543 Lbs. (246 kg)	Call
150 Person	Round	N24	132" x 45" x 46" (3340x1135x1150mm)	A-Pack 2866 Lbs. (1300 kg)	N/A
		N23	132" x 41" x 42" (3340x1035x1050mm)	B-Pack 1941 Lbs. (880 kg)	N/A

PLEASE VISIT [WWW.SURVITECZODIAC.COM](http://WWW.SURVITECZODIAC.COM) FOR DATASHEETS AND CERTIFICATIONS AVAILABLE ONLINE.

# THROW-OVER LIFERAFTS



**APPROVALS**



Manufactured from durable butyl fabric, ensuring its durability

Fully enclosed double skinned high visibility canopy complete with SOLAS-grade reflective tape

Non-inflatable easy access boarding ramp

Rafts come packed in containers with hydrostatic release unit (HRU) assembly, lashing and cradle for U.S. product only

FOR PROPER PACKING, PLEASE INDICATE VESSEL LAUNCH HEIGHT WHEN ORDERING



MODEL / CAPACITY	CONTAINER TYPE / SIZE	A X B* X C DIMS	SOLAS PACK TYPE / WEIGHT	USCG MODEL PRODUCT #	TC MODEL PRODUCT #
SeaFort 4 Person	Low Profile Size 2	34" x 23" x 13" (870x320x570mm)	128 Lbs. (58kg) A-Pack	DFT55002	DFT07002
		34" x 23" x 13" (870x320x570mm)	92 Lbs. (42kg) B-Pack	DFT56002	DFT08002
	Round	34" x 19" x 19" (870x500x500mm)	132 Lbs. (60kg) A-Pack	DFT55102	DFT07102
		34" x 19" x 19" (870x500x500mm)	112 Lbs. (50kg) B-Pack	DFT56102	DFT08102
SeaFort 6 Person	Low Profile	34" x 23" x 16" (870x410x570mm)	145 Lbs. (66kg) A-Pack	DFT55014	DFT07016
		34" x 23" x 16" (870x410x570mm)	121 Lbs. (55kg) B-Pack	DFT56016	DFT08016
	Round	40" x 19" x 19" (1020x500x500mm)	156 Lbs. (71kg) A-Pack	DFT55116	DFT07116
		40" x 19" x 19" (1020x500x500mm)	128 Lbs. (58kg) B-Pack	DFT56116	DFT08116
SeaFort 8 Person	Low Profile	35" x 25" x 17" (890x430x625mm)	178 Lbs. (81kg) A-Pack	DFT55034	DFT07020
		35" x 23" x 16" (870x410x570mm)	144 Lbs. (65kg) B-Pack	DFT56020	DFT08020
	Round	41" x 23" x 23" (1040x580x580mm)	188 Lbs. (85kg) A-Pack	DFT55120	DFT07120
		41" x 23" x 23" (1040x580x580mm)	154 Lbs. (70kg) B-Pack	DFT56120	DFT08120
SeaFort 10 Person	Round	45" x 26" x 26" (1140x660x660mm)	211 Lbs. (96kg) A-Pack	DFT55134	DFT05134
		45" x 26" x 26" (1140x660x660mm)	167 Lbs. (76kg) B-Pack	DFT56134	DFT06134
SeaFort 16 Person	Round	49" x 27" x 27" (1250x690x690mm)	332 Lbs. (151kg) A-Pack	DFT55152	DFT05152
		49" x 27" x 27" (1250x690x690mm)	264 Lbs. (120kg) B-Pack	DFT56152	DFT06152
SeaFort 25 Person	Round	54" x 29" x 29" (1370x740x740mm)	389 Lbs. (176kg) A-Pack	DFT55170	DFT05170
		54" x 29" x 29" (1370x740x740mm)	289 Lbs. (131kg) B-Pack	DFT56170	DFT06170
SeaFort 50 Person	Round	61" x 31" x 31" (1550x780x780mm)	659 Lbs. (299kg) A-Pack	DFT55184	DFT05184
		61" x 31" x 31" (1550x780x780mm)	455 Lbs. (206kg) B-Pack	DFT56184	DFT06184

\*B DIMENSION FOR SEAFORT LIFERAFT ROUND CONTAINERS ARE NOT INCLUSIVE OF CRADLE. PLEASE VISIT [WWW.DBCMARINE.COM](http://WWW.DBCMARINE.COM) FOR DATASHEETS AND CERTIFICATIONS AVAILABLE ONLINE.



# LIFERAFT DECELERATING SYSTEM

The liferaft decelerating system is suitable for installation on a tilting or fixed cradle, without modification to the existing cradle installation

The system consists of:  
 a pocket (#3 in the diagram);  
 2 "U" bolts (#2 in the diagram) fitted onto the upper shell of the container; a painter line of suitable length for the distance of the drop ((#1 in the diagram)

The loose end of the decelerating system and the painter line are connected to the HRU (#4 in the diagram)

Throw-over liferafts fitted with a decelerating system are MED approved up to 50 meters installation height



Contact us to order and to learn more about possible offshore applications on high freeboard oil and gas platforms

Designed for **extreme height storage** of liferaft containers (up to 50 meters), such as those fitted onboard Offshore or Oil Rig installations. This system allows the stowage height of SurvitecZodiac throw-over liferafts, packed in round containers, to be increased over the standard approved stowage height. It does this by controlling the descent speed of the liferaft during the major part of its fall, thus reducing the impact of the liferaft on the water and bringing additional safety.

Installation of a liferaft configured to use the decelerating system on deck is simple and operation is similar to conventional throw-over liferafts. There is no special operation or training needed for the crew in order to launch a liferaft fitted with the system.

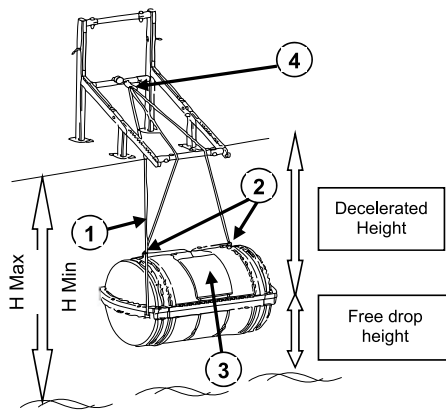

# LIFERAFT CONTAINER ROLL-OFF CRADLES

Survitec Group offers single, double and triple liferaft container roll-off cradles. They are designed to accommodate liferaft containers with 6 - 50 person capacities. Each liferaft is individually released either by HRU or manually. The cradle is of welded steel construction and is hot dip galvanized to maximize corrosion resistance. All fastening are of stainless steel.

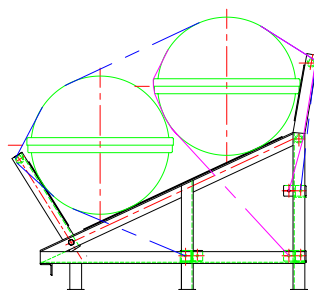

**DOUBLE LIFERAFT CONTAINER ROLL-OFF CRADLE**

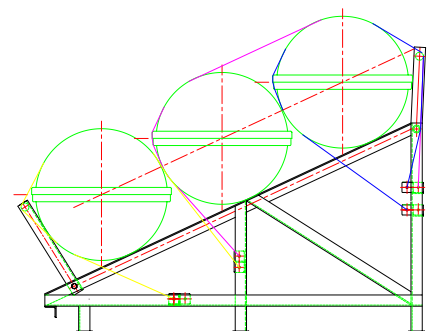

**TRIPLE LIFERAFT CONTAINER ROLL-OFF CRADLE**

Please contact your Sales Manager for specifications, pricing, availability and ordering information



# DAVIT-LAUNCH LIFERAFTS



Elliot davit-launch liferafts are manufactured to the highest quality standards and stowed in cylindrical containers designed to suit most deck spaces. Manufactured from polyurethane (PU) coated nylon, ensuring the durability of the liferaft.

Fully enclosed double skinned high visibility canopy complete with SOLAS-grade reflective tape

Non-inflatable easy access boarding ramp

High volume water pockets to ensure maximum stability when inflated

Canopy fitted with LED light ensuring maximum visibility

Fully insulated floor to ensure maximum thermal protection

Stowed in lightweight streamlined GRP containers enabling maximum deck space utilization

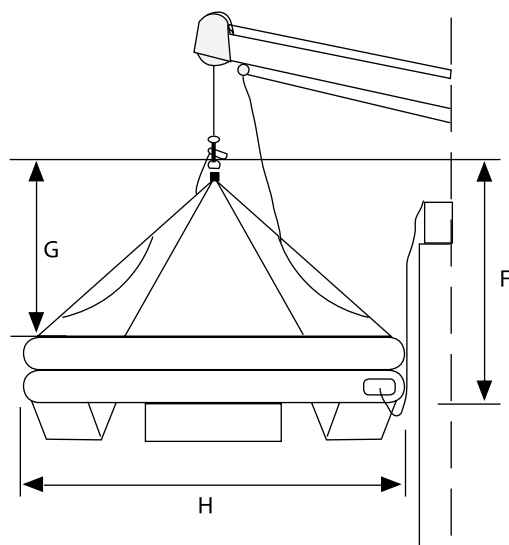
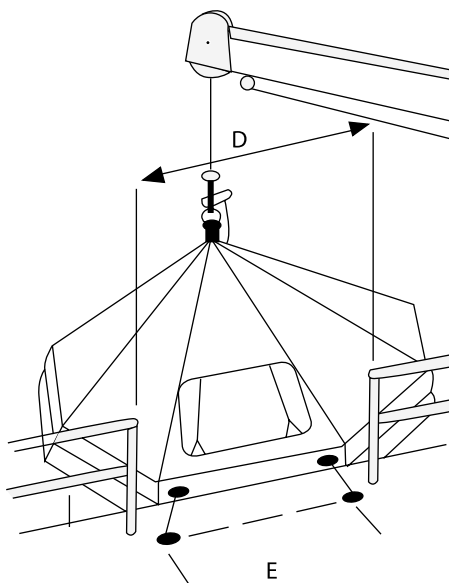

MODEL / CAPACITY	CONTAINER TYPE	A X B X C DIMS	SOLAS PACK TYPE / WEIGHT	D X E X F X G X H DIMS	PRODUCT #	SGSC
12 Person	Round	55" X 28" X 23"	A-Pack 251 Lbs.	63" x 39" x 75" x 51" x 113"	00011503E	
		Call	B-Pack Call	63" x 39" x 75" x 51" x 113"	Call	
16 Person	Round	61" X 28" X 23"	A-Pack 306 Lbs.	67" x 39" x 82" x 56" x 129"	00041562E	
		Call	B-Pack Call	67" x 39" x 82" x 56" x 129"	Call	
20 Person	Round	64" x 30" x 25"	A-Pack 353 Lbs.	71" x 39" x 82" x 55" x 160"	00012586E	
		Call	B-Pack Call	71" x 39" x 82" x 55" x 160"	Call	
25 Person	Round	64" x 30" x 25"	A-Pack 403 Lbs.	71" x 39" x 90" x 61" x 160"	00013629E	
		Call	B-Pack Call	71" x 39" x 90" x 61" x 160"	Call	

TO ENSURE YOU ARE PURCHASING THE CORRECT LIFERAFT FOR YOUR APPLICATION, PLEASE SPEAK TO YOUR SALES COORDINATOR OR MANAGER WHEN ORDERING

# CREWSAVER

## DAVIT-LAUNCH LIFERAFTS

Fully enclosed double skinned high visibility canopy complete with SOLAS-grade reflective tape

Non-inflatable easy access boarding ramp

High volume water pockets to ensure maximum stability when inflated

Canopy fitted with LED light ensuring maximum visibility

Fully insulated floor to ensure maximum thermal protection

Stowed in lightweight streamlined GRP containers enabling maximum deck space utilization



MODEL / CAPACITY	CONTAINER TYPE	DROP HEIGHT	A X B X C DIMS	SOLAS PACK TYPE / WEIGHT	D X E X F X G X H DIMS	PRODUCT #	SGSC
12 Person	Round	36 Meter	55" X 28" X 23"	A-Pack 251 Lbs.	63" x 39" x 75" x 51" x 113"	00011503C	
			Call	B-Pack Call	63" x 39" x 75" x 51" x 113"	Call	
20 Person	Round	36 Meter	64" x 30" x 25"	A-Pack 353 Lbs.	71" x 39" x 82" x 55" x 160"	00012586C	
			Call	B-Pack Call	71" x 39" x 82" x 55" x 160"	Call	
25 Person	Round	36 Meter	64" x 30" x 25"	A-Pack 403 Lbs.	71" x 39" x 90" x 61" x 160"	00013629C	
			Call	B-Pack Call	71" x 39" x 90" x 61" x 160"	Call	
		46 Meter	64" x 30" x 25"	A-Pack 403 Lbs.	71" x 39" x 90" x 61" x 160"	00013714C	
			Call	B-Pack Call	71" x 39" x 90" x 61" x 160"	Call	



## DAVIT-LAUNCH LIFERAFTS

Fully enclosed double skinned high visibility canopy complete with SOLAS-grade reflective tape

Non-inflatable easy access boarding ramp

High volume water pockets to ensure maximum stability when inflated

Canopy fitted with LED light ensuring maximum visibility

Fully insulated floor to ensure maximum thermal protection

Stowed in lightweight streamlined GRP containers enabling maximum deck space utilization

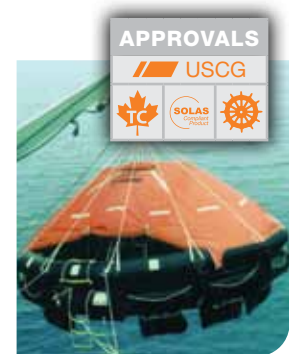

MODEL / CAPACITY	CONTAINER TYPE	A X B X C DIMS	WEIGHT	D X E X F X G X H DIMS	PRODUCT #	SGSC
Surviva 20 Person	Round	64" x 28" x 23"	353 Lbs.	71" x 39" x 82" x 55" x 160"	00012598	
Surviva 25 Person	Round	64" x 28" x 23"	406 Lbs.	71" x 39" x 90" x 61" x 160"	00013612	

TO ENSURE YOU ARE PURCHASING THE CORRECT LIFERAFT FOR YOUR APPLICATION, PLEASE SPEAK TO YOUR SALES COORDINATOR OR MANAGER WHEN ORDERING



# DAVIT-LAUNCH LIFERAFTS

The LR07 is the latest MED approved DSB liferaft which provides a quality product that is both durable and cost effective. Stability, insulation, visibility and ease of stowage all feature highly in the design of this liferaft.



Manufactured from polyurethane (PU) coated nylon, ensuring its durability

Fully enclosed double skinned high visibility canopy complete with retro reflective tape

Semi-rigid easy access boarding ramp

Fully insulated floor to ensure maximum thermal protection

Large water pockets to ensure maximum stability when liferaft is inflated

As with all Davit Launch liferafts each raft is designed to be deployed on a davit and have all passengers boarded before being safely lowered to the water

USCG MODEL / CAPACITY	CONTAINER TYPE	A X B X C DIMS	WEIGHT	PRODUCT #	SG SC
LR07 12 Person	Round	50" x 19" x 19"	249 Lbs.	00011629	
LR07 16 Person	Round	52" x 27" x 27"	311 Lbs.	00041553	
LR07 20 Person	Round	52" x 27" x 27"	359 Lbs.	00012675	
LR07 25 Person	Round	52" x 27" x 27"	408 Lbs.	00013764	

MED MODEL / CAPACITY	CONTAINER TYPE	A X B X C DIMS	WEIGHT	PRODUCT #	SG SC
LR07 12 Person	Round	50" x 19" x 19"	249 Lbs.	00011586	
LR07 16 Person	Round	52" x 27" x 27"	311 Lbs.	00041515	
LR07 20 Person	Round	52" x 27" x 27"	359 Lbs.	00012622	
LR07 25 Person	Round	52" x 27" x 27"	408 Lbs.	00013689	



## DAVIT-LAUNCH LIFERAFTS



SSP OceanMaster davit-launch liferafts are renowned for uncompromising quality and design sophistication. In addition to meeting the requirements of the International Convention of the Safety of Life at Sea (SOLAS) 1996, as amended the OceanMaster is manufactured to NATO AQAP 1 quality standards and holds approvals from most major international marine authorities, including the United States Coast Guard and UK Department of Trade.

Designed to be launched by a davit, OceanMaster davit-launch liferafts can also be dropped from up to 36 meters in emergency evacuation conditions.

18 METER HIGH STOWAGE MODEL / CAPACITY	CONTAINER TYPE	A X B X C DIMENSIONS	SOLAS PACK TYPE / WEIGHT		PRODUCT #	SG JV
OceanMaster 12 Person	Round	55" x 26" x 21"	A-Pack	251 Lbs.	50-R/R-12M-A-DL	
		55" x 26" x 21"	B-Pack	208 Lbs.	50-R/R-12M-B-DL	
OceanMaster 16 Person	Round	61" x 26" x 21"	A-Pack	306 Lbs.	50-R/R-16M-DL-A	
		61" x 26" x 21"	B-Pack	247 Lbs.	50-R/R-16M-DL-B	
OceanMaster 20 Person	Round	64" x 28" x 23"	A-Pack	353 Lbs.	50-R/R-20M-DL-A	
		64" x 28" x 23"	B-Pack	265 Lbs.	50-R/R-20M-DL-B	
OceanMaster 25 Person	Round	64" x 28" x 23"	A-Pack	406 Lbs.	50-R/R-25M-DL-A	
		64" x 28" x 23"	B-Pack	318 Lbs.	50-R/R-25M-DL-B	

*28/36 METER HIGH STOWAGE HIGH-DROP MODEL / CAPACITY	CONTAINER TYPE	A X B X C DIMENSIONS	SOLAS PACK TYPE / WEIGHT		PRODUCT #	SG JV
OceanMaster 12 Person	Round	55" x 26" x 21"	A-Pack	251 Lbs.	50-R/R-12M-DL-HD	
OceanMaster 16 Person	Round	61" x 26" x 21"	A-Pack	306 Lbs.	50-R/R-16M-DL-HD	
OceanMaster 20 Person	Round	64" x 28" x 23"	A-Pack	353 Lbs.	50-R/R-20M-DL-HD	
OceanMaster 25 Person	Round	64" x 28" x 23"	A-Pack	406 Lbs.	50-R/R-25M-DL-HD	

\*ORDERS FOR HIGH-DROP MODELS MUST LIST DESIRED STOWAGE HEIGHT OF 28 OR 36 METERS



## DAVIT-LAUNCH LIFERAFTS

18 METER HIGH STOWAGE MODEL / CAPACITY	CONTAINER TYPE	A X B X C DIMENSIONS	SOLAS PACK TYPE / WEIGHT		PRODUCT #	SG JV
Guardian 12 Person	Round	55" x 26" x 21"	A-Pack	251 Lbs.	50-NWG12-DL-R	
Guardian 16 Person	Round	61" x 26" x 21"	A-Pack	306 Lbs.	50-NWG16-DL-R	
Guardian 20 Person	Round	64" x 28" x 23"	A-Pack	353 Lbs.	50-NWG20-DL-R	
Guardian 25 Person	Round	64" x 28" x 23"	A-Pack	406 Lbs.	50-NWG25-DL-R	





# DAVIT-LAUNCH LIFERAFTS



Manufactured with durable polyurethane (PU) coated fabric, all SurvitecZodiac davit-launch liferafts are assembled using the advanced SurvitecZodiac hot assembly technique, Thermobonding™.

Designed to be launched by a davit, SurvitecZodiac davit launch liferafts can also be dropped from up to 36 meters in emergency evacuation conditions.

Raft fabric weight and structure allow for easy servicing

Light, more compact GRP container design gives quick access to the lifting bridle

All liferafts are submitted to 4 times overload test and fully loaded 10 foot drop test, side impact and abrasion test

Equipment pack is sealed in a strong watertight bag and secured to the internal safety line of the liferaft

Rafts come packed in containers with hydrostatic release unit (HRU) assembly, lashing and cradle for U.S. product only

FOR PROPER PACKING, PLEASE INDICATE VESSEL LAUNCH HEIGHT WHEN ORDERING



CAPACITY	CONTAINER TYPE	A X B X C DIMS	SOLAS PACK TYPE / WEIGHT	USCG MODEL PRODUCT #	TC MODEL PRODUCT #
12 A pack	Round	N15B 51" x 30" x 32" (1275x740x800mm)	A-Pack 320 Lbs. (145 kg)	DRZ0558	DRZ0966
12 B pack	Round	N14B 51" x 25" x 27" (1275x615x680mm)	B-Pack 243 Lbs. (110 kg)	DRZ0559	DRZ0967
16 A pack	Round	N15B 51" x 30" x 32" (1275x740x800mm)	A-Pack 342 Lbs. (155 kg)	DRZ0577	DRZ0968
16 B pack	Round	N14B 51" x 25" x 27" (1275x615x680mm)	B-Pack 243 Lbs. (110 kg)	DRZ0578	DRZ0969
20 A pack	Round	N15B 51" x 30" x 32" (1275x740x800mm)	A-Pack 353 Lbs. (160 kg)	DRZ0600	DRZ0972
20 B pack	Round	N14B 51" x 25" x 27" (1275x615x680mm)	B-Pack 254 Lbs. (115 kg)	DRZ0602	DRZ0973
25 A pack	Round	N16B 58" x 30" x 32" (1450x740x800mm)	A-Pack 441 Lbs. (200 kg)	DRZ0970	DRZ0924
25 B pack	Round	N15B 51" x 30" x 32" (1275x740x800mm)	B-Pack 309 Lbs. (140 kg)	DRZ0971	DRZ0925
37 A pack	Round	N17B 60" x 38" x 38" (1500x945x950mm)	A-Pack 684 Lbs. (310 kg)	DRZ0445	DRZ0929
37 B pack	Round	N16B 58" x 30" x 32" (1450x740x800mm)	B-Pack 441 Lbs. (200 kg)	DRZ0604	DRZ0974

# SELF-RIGHTING DAVIT-LAUNCH LIFERAFTS



FOR PROPER PACKING, PLEASE INDICATE VESSEL LAUNCH HEIGHT WHEN ORDERING



CAPACITY	CONTAINER TYPE	A X B X C DIMS	SOLAS PACK TYPE / WEIGHT	USCG MODEL PRODUCT #	TC MODEL PRODUCT #
25 A pack	Round	N16B 58" x 30" x 32" (1450x740x800mm)	A-Pack 486 Lbs. (220 kg)	Call	DRZ0601
25 B pack	Round	N22B 61" x 35" x 34" (1530x880x845mm)	B-Pack 353 Lbs. (160 kg)	Call	DRZ0609
37 A pack	Round	N17B 60" x 38" x 38" (1500x945x950mm)	A-Pack 728 Lbs. (330 kg)	Call	DRZ0953
37 B pack	Round	N18B 62" x 33" x 34" (1560x835x850mm)	B-Pack 508 Lbs. (230 kg)	Call	DRZ0955

PLEASE VISIT [WWW.SURVITECZODIAC.COM](http://WWW.SURVITECZODIAC.COM) FOR DATASHEETS AND CERTIFICATIONS AVAILABLE ONLINE.



# DAVIT-LAUNCH LIFERAFT STACKING CRADLE

Designed for both shipyards and operators, the davit-launch liferaft with stackable containers perfectly addresses their need for a simple and easily operated solution which provides a complete set of these liferafts with reduced operation for deck installation.

The liferafts are delivered completely fitted with their lashing, HRU and the painters connected. They are set up on a galvanized steel cradle either as a single liferaft or a set of 2 liferafts.



**INSTALLATION ON DECK ONLY REQUIRES THE WELDING OF 2 STEEL HINGES**



**DELIVERED PRE-FITTED ON THEIR DECK CRADLE, THE LIFERAFTS BECOME EASILY PORTABLE DURING INSTALLATION OR REMOVAL FOR SERVICING BY EITHER A PALLET JACK OR FORKLIFT**



LIFERAFT MODEL / CAPACITY	MOUNT TYPE / CONTAINER TYPE			A X B X C DIMS	SOLAS PACK TYPE / WEIGHT		PRODUCT #	SG V N
25 Person Davit-Launch	Single	Round	N16B	58" x 30" x 32" (1450x740x800mm)	A-Pack	486 Lbs. (220 kg)	Call	
	Single	Round	N22B	61" x 35" x 34" (1530x880x845mm)	B-Pack	353 Lbs. (160 kg)	Call	
	Double	Round	N16B	58" x 30" x 32" (1450x740x800mm)	A-Pack	971 Lbs. (440 kg)	Call	
	Double	Round	N22B	61" x 35" x 34" (1530x880x845mm)	B-Pack	706 Lbs. (320 kg)	Call	
37 Person Davit-Launch	Single	Round	N17B	60" x 38" x 38" (1500x945x950mm)	A-Pack	728 Lbs. (330 kg)	Call	
	Single	Round	N18B	62" x 33" x 34" (1560x835x850mm)	B-Pack	508 Lbs. (230 kg)	Call	
	Double	Round	N17B	60" x 38" x 38" (1500x945x950mm)	A-Pack	1456 Lbs. (660 kg)	Call	
	Double	Round	N18B	62" x 33" x 34" (1560x835x850mm)	B-Pack	1016 Lbs. (460 kg)	Call	
37 Person Davit-Launch Self-Righting	Single	Round	N18B	62" x 33" x 34" (1560x835x850mm)	B-Pack	508 Lbs. (230 kg)	Call	
	Double	Round	N18B	62" x 33" x 34" (1560x835x850mm)	B-Pack	1016 Lbs. (460 kg)	Call	



**SINGLE STACK**



**DOUBLE STACK**

PLEASE VISIT [WWW.SURVITECZODIAC.COM](http://WWW.SURVITECZODIAC.COM) FOR DATASHEETS AND CERTIFICATIONS AVAILABLE ONLINE.



# COASTAL LIFERAFTS



Elliot liferafts benefit from high frequency welding and polyurethane proofed nylon fabric material to produce a higher quality, longer lasting liferaft than those produced from rubber-based fabrics with glued seams. Our Coastal liferafts offer double buoyancy chambers, are highly abrasion resistant, impervious to corrosion in the harsh marine environment and are USCG approved.

MODEL / CAPACITY	CONTAINER	A X B X C DIMS	WEIGHT	PRODUCT #	SG SC
4 Person	Low Profile	34" x 21" x 12"	80 Lbs.	00007243	
	Valise	31" x 18" x 13"	69 Lbs.	00007241	
6 Person	Low Profile	34" x 21" x 14"	104 Lbs.	00008441	
	Valise	31" x 20" x 15"	90 Lbs.	00008542	
8 Person	Low Profile	34" x 21" x 14"	116 Lbs.	00009468	
	Valise	31" x 20" x 15"	102 Lbs.	00009391	

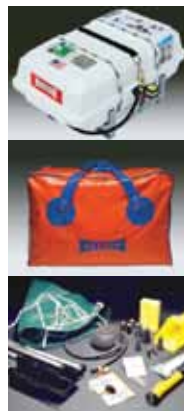

All rafts in containers come with hydrostatic release unit (HRU) assembly and cradle

Equipment Pack including bailers, sponges, hand pump, paddles, signal mirrors, knife, sea anchor and more

# COASTAL LIFERAFTS

# CREWSAVER

Similar to Elliot liferafts, Crewsaver liferafts feature high frequency welding, polyurethane proofed nylon fabric material, double buoyancy chambers, high abrasion resistance, an imperviousness to the marine environment and USCG approval.



All rafts in containers come with hydrostatic release unit (HRU) assembly and cradle

Equipment Pack including bailers, sponges, hand pump, paddles, signal mirrors, knife, sea anchor and more

MODEL / CAPACITY	CONTAINER	A X B X C DIMS	WEIGHT	PRODUCT #	SG SC
4 Person	Low Profile	34" x 21" x 12"	80 Lbs.	00007244	
	Valise	31" x 18" x 13"	69 Lbs.	00007242	
6 Person	Low Profile	34" x 21" x 14"	104 Lbs.	00008442	
	Valise	31" x 20" x 15"	90 Lbs.	00008440	
8 Person	Low Profile	34" x 21" x 14"	116 Lbs.	00009469	
	Valise	31" x 20" x 15"	102 Lbs.	00009390	



# COASTAL LIFERAFTS

All rafts in containers come with hydrostatic release unit (HRU) assembly and cradle

Equipment Pack including bailers, sponges, hand pump, paddles, signal mirrors, knife, sea anchor and more

The SSP SeaMaster has double buoyancy chambers manufactured from a specially formulated polyurethane (PU) proofed nylon fabric which is highly resistant to abrasion and impervious to corrosion in the marine environment. All 8-person SeaMaster liferafts include a boarding ramp, built-in canopy and equipment pack. SeaMaster liferafts of all sizes may be packed in either a low profile container or a lightweight, durable, water-resistant valise which makes it easy to launch the raft overboard.



**STANDARD EQUIPMENT PACK**

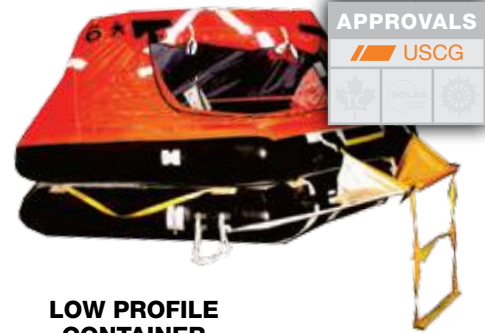

**LOW PROFILE CONTAINER**



**VALISE**

MODEL / CAPACITY	CONTAINER TYPE	A X B X C DIMS	WEIGHT	PRODUCT #	SG JV
SeaMaster 4 Person	Low Profile	50" x 21" x 19"	80 Lbs.	50-R/R-4M-C-L	
	Valise	38" x 26.5" x 16.5"	69 Lbs.	50-R/R-4M-C-V	
SeaMaster 6 Person	Low Profile	50" x 21" x 19"	104 Lbs.	50-R/R-6M-C-L	
	Valise	38" x 26.5" x 16.5"	90 Lbs.	50-R/R-6M-C-V	
SeaMaster 8 Person	Low Profile	55" x 23" x 21"	106 Lbs.	50-R/R-8M-C-L	
	Valise	55" x 23" x 21"	92 Lbs.	50-R/R-8M-C-V	



# COASTAL LIFERAFTS



SurvitecZodiac Coastal liferafts feature dual buoyancy chambers and Thermobonded construction, with availability in both a container and a valise. Rafts come packed in containers with hydrostatic release unit (HRU) assembly, lashing and cradle for U.S. product only.



**VALISE**



**LOW PROFILE CONTAINER**

MODEL / CAPACITY	CONTAINER TYPE		A X B X C DIMS	WEIGHT	USCG MODEL PRODUCT #	TC MODEL PRODUCT #	SG V N
4 Person	Low Profile	N131	32" x 13" x 18" (810x330x440mm)	82 Lbs. (37 kg)	DRZ0742	DRZ35007	
	Valise		32" x 13" x 17" (810x300x410mm)	67 Lbs. (30 kg)	DRZ35011	DRZ35014	
6 Person	Low Profile	N131	32" x 13" x 18" (810x330x440mm)	84 Lbs. (38 kg)	DRZ07409	DRZ35008	
	Valise		34" x 13" x 21" (860x330x510mm)	71 Lbs. (32 kg)	DRZ35012	DRZ35015	
8 Person	Low Profile	N132	36" x 13" x 18" (890x330x440mm)	111 Lbs. (50 kg)	DRZ0741	DRZ35009	
	Low Profile	N132	36" x 13" x 18" (890x330x440mm)	111 Lbs. (50 kg)	N/A	DRZ35006	
	Valise		36" x 13" x 21" (910x330x510mm)	89 Lbs. (40 kg)	DRZ35013	DRZ35016	

PLEASE VISIT [WWW.SURVITECZODIAC.COM](http://WWW.SURVITECZODIAC.COM) FOR DATASHEETS AND CERTIFICATIONS AVAILABLE ONLINE

## EPE COASTAL LIFERAFTS

30-month extended service interval Coastal liferafts with TC only approvals are available. Please contact us for additional information or to order.

CANADA CAPACITY	CONTAINER TYPE	TC MODEL PRODUCT #	SG V N
4 Person	Round	DRZ35004	
6 Person	Round	DRZ33006	
8 Person	Round	DRZ33007	



# COASTAL LIFERAFTS

The DBC Coastal liferaft has been specifically designed to meet Transport Canada and USCG regulations. Constructed to offer the utmost in safety, the Coastal liferafts are manufactured to the same standards as our SOLAS approved liferafts.

## LOW PROFILE CONTAINER

Heavy weight butyl fabric construction

10 year fabric and seam warranty (subject to annual servicing by DBC approved service station).

Rafts come packed in containers with hydrostatic release unit (HRU) assembly, lashing and cradle for U.S. product only



## VALISE



U.S. CAPACITY	CANADA CAPACITY	CONTAINER TYPE	CONTAINER SIZE		A X B X C DIMS	WEIGHT	USCG MODEL PRODUCT #	TC MODEL PRODUCT #
			USCG	TC				
4 Person	4 Person	Low Profile	1	2	34" x 13" x 23" (870x320x570mm)	94 Lbs. (43kg)	DCS01504	DCS03006
		Valise	2	2	30" x 12" x 13" (760x300x330mm)	69 Lbs. (31kg)	DCS01016	DCS03106
6 Person	6 Person	Low Profile	2	2	34" x 13" x 23" (870x320x570mm)	103 Lbs. (47kg)	DCS01516	DCS03012
		Valise	3	3	33" x 14" x 16" (840x360x410mm)	74 Lbs. (34kg)	DCS02022	DCS03112
8 Person	8 Person	Low Profile	3	3	34" x 16" x 23" (870x410x570mm)	121 Lbs. (55kg)	DCS01528	DCS03018
		Valise	4	4	36" x 16" x 18" (910x410x460mm)	83 Lbs. (38kg)	DCS02036	DCS03118

PLEASE VISIT [WWW.DBCMARINE.COM](http://WWW.DBCMARINE.COM) FOR DATASHEETS AND CERTIFICATIONS AVAILABLE ONLINE.

# INFLATABLE BUOYANT APPARATUS (IBA)



**ROUND CONTAINER**

**LOW PROFILE CONTAINER**

**VALISE**



**4-8 PERSON IBA**



**25-50 PERSON IBA**



**100 PERSON IBA**

Designed and certified for passenger and/or commercial fishing vessels operating in protected or in-shore waters

25, 50 and 100 person capacities are fully reversible

Constructed of Polyurethane coated nylon fabric for superior abrasion resistance

Manufactured using radio frequency (RF) welded seams for increased strength and reliability

Outfitted with applicable government specified emergency equipment

Optional roll-off cradles are available for single, double and triple container mounting/stowage

MODEL / CAPACITY	CONTAINER TYPE	A X B X C DIMS	WEIGHT	PRODUCT #	SGSC
4 Person	Low Profile	34" x 15" x 20"	66 Lbs.	00007239E	
	Valise	31" x 13" x 18"	54 Lbs.	00007237E	
6 Person	Low Profile	34" x 16" x 20"	86 Lbs.	00008437E	
	Valise	31" x 15" x 20"	73 Lbs.	00008435E	
8 Person	Low Profile	34" x 14" x 21"	92 Lbs.	00009386E	
	Valise	30" x 13" x 23"	79 Lbs.	00009384E	
25 Person	Round	61" x 26" x 23"	225 Lbs.	00055015E	
50 Person	Round	65" x 29" x 25"	355 Lbs.	00056034E	
100 Person (Twin 50)*	Round	68" x 35" x 30"	660 Lbs.	00057017E	

\* NOTE LAUNCH RACK NOT INCLUDED - ALL HARDWARE SOLD SEPARATELY

# CREWSAVER

## INFLATABLE BUOYANT APPARATUS (IBA)

Designed and certified for passenger and/or commercial fishing vessels operating in protected or in-shore waters

25, 50 and 100 person capacities are fully reversible

Constructed of that Polyurethane coated nylon fabric for superior abrasion resistance

Manufactured using radio frequency (RF) welded seams for increased strength and reliability

Outfitted with applicable government specified emergency equipment

Optional roll-off cradles are available for single, double and triple container mounting/stowage



**ROUND CONTAINER**

**LOW PROFILE CONTAINER**

**VALISE**

MODEL / CAPACITY	CONTAINER TYPE	A X B X C DIMS	WEIGHT	PRODUCT #	SGSC
4 Person	Low Profile	34" x 15" x 20"	66 Lbs.	00007240C	
	Valise	31" x 13" x 18"	54 Lbs.	00007238C	
6 Person	Low Profile	34" x 16" x 20"	86 Lbs.	00008438C	
	Valise	31" x 15" x 20"	73 Lbs.	00008436C	
8 Person	Low Profile	34" x 14" x 21"	92 Lbs.	00009387C	
	Valise	30" x 13" x 23"	79 Lbs.	00009385C	

CREWSAVER INFLATABLE BUOYANT APPARATUS ALSO AVAILABLE IN 25, 50 AND 100 PERSON CONFIGURATIONS. PLEASE SPEAK TO YOUR SALES COORDINATOR OR MANAGER WHEN ORDERING



# INFLATABLE BUOYANT APPARATUS (IBA)



The ShoreMaster IBA offers double buoyancy chambers which are constructed from specially formulated polyurethane (PU) proofed nylon fabric, which is highly resistant to abrasion and impervious to corrosion in the marine environment. Welded seams make this raft impervious to wear and tear. All 8-man ShoreMaster IBAs include a boarding ladder, rescue light and equipment pack.

A lightweight, water-resistant, durable valise is available for all sizes of ShoreMaster liferafts. Valises are made of a high visibility material, and are easy to launch overboard. Also available in Low Profile Container.



**LOW PROFILE CONTAINER**



**VALISE**

All IBAs in containers come with hydrostatic release unit (HRU) assembly and cradle

Equipment Pack including bailers, sponges, hand pump, paddles, signal mirrors, knife, sea anchor and more

MODEL / CAPACITY	CONTAINER TYPE	A X B X C DIMS	WEIGHT	PRODUCT #	SG JV
ShoreMaster 4 Person	Low Profile	34" x 20" x 11.5"	68 Lbs.	50-R/R-4M-IBA-L	
	Valise	31" x 18" x 13"	56 Lbs.	50-R/R-4M-IBA-V	
ShoreMaster 6 Person	Low Profile	34" x 20" x 13.5"	89 Lbs.	50-R/R-6M-IBA-L	
	Valise	31" x 15" x 20"	76 Lbs.	50-R/R-6M-IBA-V	
ShoreMaster 8 Person	Low Profile	34" x 20" x 13.5"	100 Lbs.	50-R/R-8M-IBA-L	
	Valise	31" x 15" x 20"	87 Lbs.	50-R/R-8M-IBA-V	



**IBA EQUIPMENT PACK**

- Compact Paddles
- Safety Knife
- Heaving Line
- Rescue Quoit
- Extra Batteries/ Bulbs
- Anti-Seasick Tablets
- Emergency Instructions
- Bailer
- Hand Pump
- 2 Sponges
- Repair Kit
- Flashlight
- Sea Anchor
- 2 PRV Bungs
- Signal Mirror



# INFLATABLE BUOYANT APPARATUS (IBA)

SurvitecZodiac IBAs are durable and have been designed for passenger-carrying vessels operating inshore on protected waters where a covered offshore liferaft is not required. A unique feature of this range is that some sizes are available in a low profile container that can be mounted either vertically or horizontally. Rafts come packed in containers with hydrostatic release unit (HRU) assembly, lashing and cradle for U.S. product only.

**IBA (SIDE VIEW)**

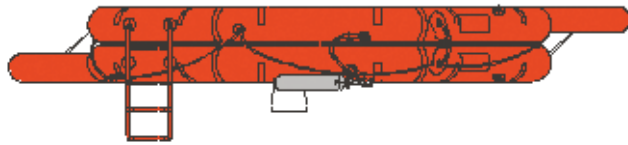

**IBA (TOP VIEW)**

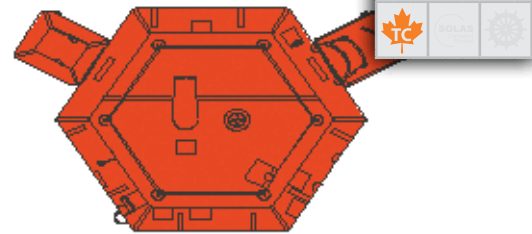

**LOW PROFILE CONTAINER**



**VALISE**



**ROUND CONTAINER**



U.S. CAPACITY	CANADA CAPACITY	CONTAINER TYPE	A X B X C DIMS	WEIGHT	USCG MODEL PRODUCT #	TC MODEL PRODUCT #
4 Person	4 Person	Low Profile	N131 33" x 13" x 22" (825x318x540mm)	64 Lbs. (29 kg)	DRZ0463	DRZ31002
		Valise	27" x 12" x 10" (690x300x250mm)	47 Lbs. (21 kg)	DRZ33115	Call
6 Person	6 Person	Round	N11 41" x 18" x 19" (1020x440x476mm)	80 Lbs. (36 kg)	DRZ1592	DRZ31003
		Low Profile	N131 33" x 13" x 22" (825x318x540mm)	78 Lbs. (35 kg)	DRZ33025	DRZ33029
10 Person	15 Person	Valise	27" x 12" x 10" (690x300x250mm)	67 Lbs. (30 kg)	DRZ33116	Call
		Round	N11 41" x 18" x 19" (1020x440x476mm)	102 Lbs. (46 kg)	DRZ1593	DRZ31015
20 Person	30 Person	Low Profile	N132 36" x 14" x 21" (890x333x520mm)	102 Lbs. (46 kg)	DRZ33026	DRZ33030
		Round	N12 46" x 21" x 23" (1160x513x560mm)	168 Lbs. (76 kg)	DRZ1594	DRZ31004
30 Person	45 Person	Low Profile	N134 38" x 15" x 24" (965x380x596mm)	166 Lbs. (75 kg)	DRZ33027	DRZ33031
		Round	N13 51" x 24" x 25" (1275x590x610mm)	221 Lbs. (100 kg)	DRZ0447	DRZ0926
50 Person	75 Person	Low Profile	N135 43" x 15" x 26" (1092x381x660mm)	219 Lbs. (99 kg)	DRZ33028	DRZ33111
		Round	N15 51" x 30" x 32" (1275x740x800mm)	369 Lbs. (167 kg)	DRZ0448	DRZ0927
100 Person	150 Person	Round	N18 62" x 33" x 34" (1560x835x852mm)	666 Lbs. (302 kg)	DRZ0576	DRZ0944

PLEASE VISIT [WWW.SURVITECZODIAC.COM](http://WWW.SURVITECZODIAC.COM) FOR DATASHEETS AND CERTIFICATIONS

CANADA CAPACITY	CONTAINER TYPE	TC MODEL PRODUCT #	SGVN
4 Person	Round	Call	
6 Person	Round	Call	
15 Person	Round	Call	
30 Person	Round	Call	
45 Person	Round	DRZ33035	
75 Person	Round	DRZ33036	
150 Person	Round	DRZ33037	

## EPE IBA LIFERAFTS

30-month extended service interval IBA liferafts with TC only approvals are available. Please contact us for additional information or to order.



# INFLATABLE BUOYANT APPARATUS (IBA)



Manufactured from durable butyl fabric

Uses Thermobonding™ hot assembly technique

Rafts come packed in containers with hydrostatic release unit (HRU) assembly, lashing and cradle for U.S. product only



U.S. CAPACITY	CANADA CAPACITY	CONTAINER TYPE	CONTAINER SIZE		A X B X C DIMS	WEIGHT	USCG MODEL PRODUCT #	TC MODEL PRODUCT #
			USCG	TC				
4 Person	4 Person	Low Profile	1	1	27" x 17.5" x 11.5" (690x440x290mm)	67 Lbs. (30kg)	DPL02540	N/A
		Valise	1	1	28" x 12" x 12" (700x300x300mm)	52 Lbs. (24kg)	DPL02068	N/A
6 Person	6 Person	Low Profile	1	1	30" x 19.5" x 11" (770x490x280mm)	82 Lbs. (37kg)	DPL02554	N/A
		Valise	1	1	28" x 12" x 12" (700x300x300mm)	57 Lbs. (26kg)	DPL02072	N/A
8 Person	8 Person	Low Profile	2	2	34" x 23" x 13" (870x570x320mm)	91 Lbs. (41kg)	DPL02590	N/A
		Valise	2	2	30" x 13" x 12" (760x330x310mm)	66 Lbs. (30kg)	DPL02107	N/A
10 Person	15 Person	Round	N/A	N/A	40" x 20" x 20" (1020x500x500mm)	159 Lbs. (72kg)	DPL02504	DPL23530
25 Person	38 Person	Round	N/A	N/A	45" x 26" x 26" (1140x660x660mm)	240 Lbs. (113kg)	DPL02518	DPL23544
50 Person	75 Person	Round	N/A	N/A	49" x 27" x 27" (1250x690x690mm)	322 Lbs. (146kg)	DPL02522	DPL23558
100 Person	150 Person	Round	N/A	N/A	74" x 35" x 35" (1870x890x890mm)	570 Lbs. (259kg)	DPL02036	DPL23062

PLEASE VISIT [WWW.DBCMARINE.COM](http://WWW.DBCMARINE.COM) FOR DATASHEETS AND CERTIFICATIONS AVAILABLE ONLINE.



# MEANS OF RESCUE (MOR)

SurvitecZodiac Means of Rescue (MOR) is a unique design specially developed to meet the latest requirements of the Roll on/Roll off passenger ships and is fully approved. These are now mandatory on RO/RO passenger ships as they provide a safe transfer of survivors from sea level to the deck of a ship in recovery situations.



**MOR**



**ROUND CONTAINER**

Manufactured with a durable polyurethane coated fabric  
 Provides extreme strength and safety when loaded  
 Assembled using the advanced SurvitecZodiac Thermobonding™ hot assembly technique, which eliminates the inconsistencies inherent in the old-fashioned gluing methods still used by other manufacturers

The fabric's chemical nature and the Thermobonding™ process make SurvitecZodiac MOR units especially inert to the aging factors in the Marine environment  
 Supplied in light, short sized strong cylindrical containers  
 Rafts come packed in distinctive orange color container, complete with hydrostatic release unit (HRU) assembly, lashing and cradle for U.S. product only

MODEL/ CAPACITY	CONTAINER TYPE	A X B X C DIMS	WEIGHT	PRODUCT #	SG VN
10 Person	Round N13B	52" x 24" x 25" (1275x590x610mm)	325 Lbs. (147 kg)	DRZ0081	

PLEASE VISIT [WWW.SURVITECZODIAC.COM](http://WWW.SURVITECZODIAC.COM) FOR DATASHEETS AND CERTIFICATIONS AVAILABLE ONLINE.

BRAND	PRODUCT DESCRIPTION • PRODUCT # • PRODUCT DETAILS	IMAGE
	<p style="text-align: center;"> <span style="border: 1px solid black; padding: 2px;">SG JV</span> <span style="border: 1px solid black; padding: 2px;">SG VN</span> </p> <p><b>H2O Hydrostatic Release</b> • 40-H20-06365009 • DRE01002 • Hydrostatic release unit fits all liferaft sizes; made of glass fiber-reinforced nylon; 2-Year usable life from date of installation</p>	
	<p><b>Universal Galvanized Steel Cradle</b> • DRZ5884 (Fits All SurvitecZodiac Round Containers Excluding 37DI, 50 TO &amp; 100 IBA) <span style="border: 1px solid black; padding: 2px;">SG VN</span></p>	
	<p><b>Stainless Steel Cradle</b> • DRZ5803 (Fits All Low Profile GRP Containers) <span style="border: 1px solid black; padding: 2px;">SG VN</span></p>	
	<p><b>Aluminum Low Profile Container Cradle</b> • DRZ03501 (Fits 4 &amp; 6 IBA &amp; 4,6 Coastal), DRZ03504 (Fits 4A &amp; B , 6B), DRZ03508 (Fits 8 Coastal &amp; 10 IBA), DRZ03502 (Fits 6A &amp; 8B, 12B &amp; 20 IBA), DRZ03503 (Fits 8A &amp; 10 A/B, 12A &amp; 30 IBA), DRZ03500 (Fits 16 A/B, 20 A/B &amp; 2009 Vintage 12A/B) <span style="border: 1px solid black; padding: 2px;">SG VN</span></p>	
	<p><b>Aluminum Round Container Cradle</b> • DRZ03416 (Fits 50 TO &amp; 100 IBA), DRZ5804 (Fits All Round Containers Except 50 TO &amp; 100 IBA) <span style="border: 1px solid black; padding: 2px;">SG VN</span></p>	<p style="text-align: center;">NO PHOTO AVAILABLE</p>
	<p><b>White Fiberglass Round Container Cradle</b> • DRZ5852 (Fits 6 A/B, 8 A/B &amp; 10B), DRZ5867(Fits 10A, 12B &amp; 16B), DRZ5862 (Fits 12A, 16, 20B &amp; 25B), DRZ5853 (Fits 20A) <span style="border: 1px solid black; padding: 2px;">SG VN</span></p>	
	<p><b>4 Person IBA Cradle</b> • DCR09103 <span style="border: 1px solid black; padding: 2px;">SG VN</span></p>	
	<p><b>Aluminum Deck Cradle C/W Lashings</b> • DCR09116 (C Size 1), DCR09124 (C Size 2), DCR09128 (C Size 3), DCR09132 (C Size 4) <span style="border: 1px solid black; padding: 2px;">SG VN</span></p>	
	<p><b>Stainless Steel Deck Cradle C/W Lashings</b> • DCR09137 (C Size 1), DCR09143 (C Size 2), DCR09146 (Seafort Size 3), DCR09149 (Seafort Size 4) <span style="border: 1px solid black; padding: 2px;">SG VN</span></p>	
<div style="display: flex; justify-content: space-between; align-items: flex-start;"> <div style="text-align: center;">      </div> <div style="text-align: center;">      </div> <div style="text-align: center;">    </div> </div>		<p>MOST SURVITEC GROUP LIFERAFTS ARE SOLD PACKED IN THEIR CONTAINER WITH CRADLE AND HRU. IF YOU WOULD LIKE TO ORDER A CRADLE WITHOUT A LIFERAFT, FOR ONE OF THE LISTED BRANDS TO THE LEFT, PLEASE CONTACT THE APPROPRIATE LOCATION FOR DETAILS.</p> <div style="text-align: right;"> <span style="border: 1px solid black; padding: 2px;">SG SC</span>  <span style="border: 1px solid black; padding: 2px;">SG JV</span>  <span style="border: 1px solid black; padding: 2px;">SG VN</span> </div>

THIS PAGE INTENTIONALLY LEFT BLANK

# MARINE EVACUATION SYSTEMS

Choosing The Right One 201 - 202

By Vessel Evacuation Heights:

Low Freeboard 203 - 205

Medium Freeboard 206 - 208

High Freeboard 209 - 211

Marine Evacuation  
For Offshore 212 - 213



# CHOOSING THE RIGHT ONE: MES

Each installation of an MES system is custom and suitable to that particular vessel. Considerations include vessel weight, type, evacuation height, number of passengers, and several other factors.

MES SUPPLY PROCESS	
0	We provide full technical assistance from the conceptual arrangement design in response to a request for quote to the final technical documentation after approval tests of the installation onboard a ship.
1	Gather the technical information for the project and prepare the proposal including a conceptual arrangement drawing of the MES, an evacuation procedure, a scope of supply, scope of price, the commercial conditions, and a technical documentation on the supplied equipment.
2	Upon receipt of the order, Survitec Group installation engineer will prepare and issue an initial general arrangement drawing with full details of the equipment and their proposed position, as well as a corresponding initial evacuation procedure. These documents, which will serve as a support for the training of crew members, will be sent to the customer for approval before commencement of the equipment production & supply.
3	The commissioning phase consists of installing the MES onboard the vessel, performing a harbor trial deployment, training of the crew members, then re-packing and re-installing the deployed equipment.
4	Final MES File: This file is composed of the commissioning report with the authorities' approval signature, the final GA drawing, the owner and installation manuals, onboard maintenance manuals for each system item and a training DVD.

In conformance with SOLAS III/20-8.1 & HSC 8.9.7, MES servicing shall always be performed in an approved SurvitecZodiac, DBC or RFD service station (depending on the MES system) and the servicing of a MES system or liferaft shall not exceed 12 months (may be extended by the Maritime Administration).

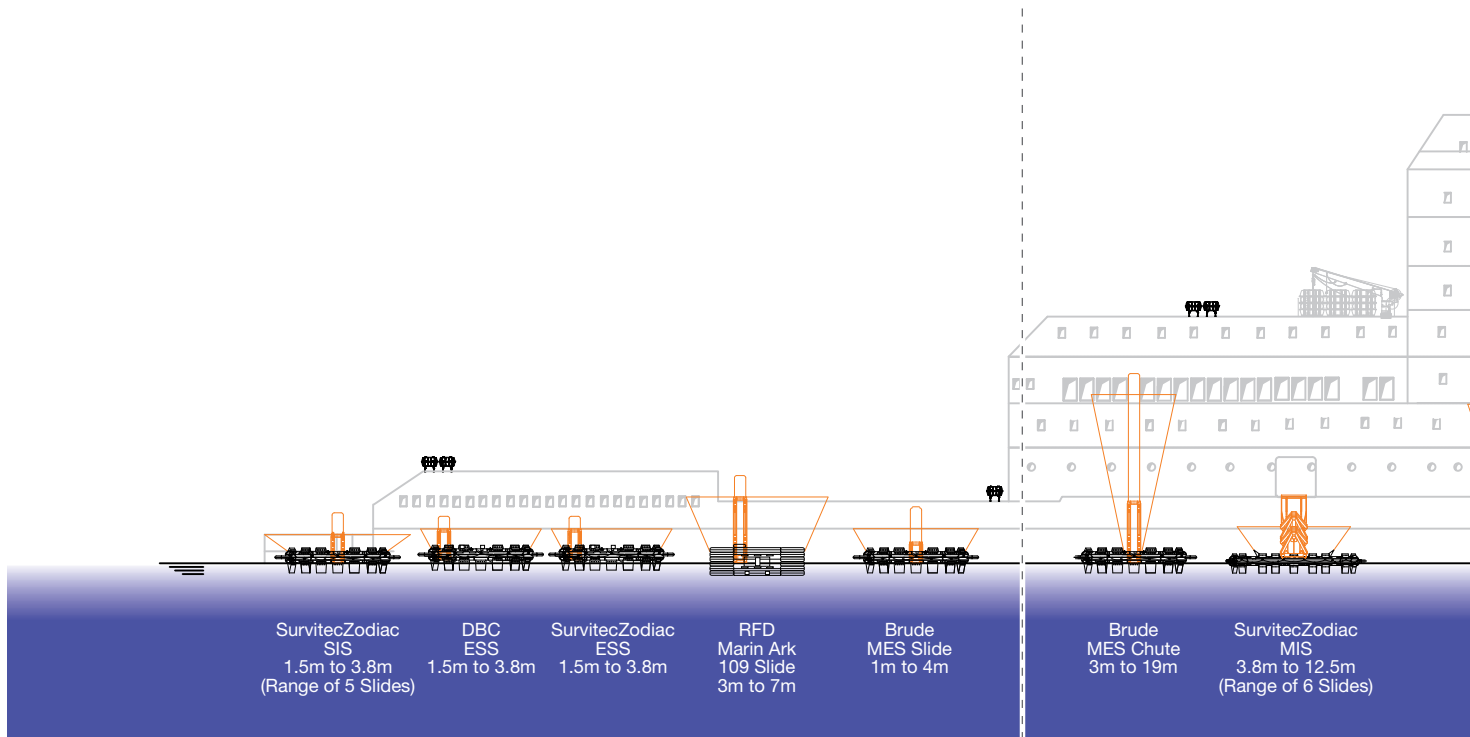



MES SYSTEM	BEST SUITED FOR	ADVANTAGES	APPROVALS	CUSTOMERS EMPLOYING SYSTEM
SurvitecZodiac Small Height Inflatable Slide System ( <b>SIS</b> ) <i>(raft &amp; slide separate)</i>	Ferries and high speed vessels requiring a relatively light-weight system such as catamarans	Lightest system available and can deploy from freeboard heights up to 3.7 meters	USCG, TC, SOLAS, EC/MED	BC Ferries, BC Department Of Highways, French Navy, Hong Kong Ferries, Newfoundland Ferries, STQ, Venecian Ferries, Washington State Ferries
DBC Emergency Slide System ( <b>ESS</b> )	Smaller vessels with the lowest evacuation points	Can deploy from freeboard heights up to 4 meters, and be activated by as few as one crew member	USCG, TC	BC Ferries, Jadrolinja, Pamarian
SurvitecZodiac Emergency Slide System ( <b>ESS</b> )				
Brude MES Slide System and MES Chute System	Vessels with low or medium evacuation points	Slide system can deploy from freeboard heights of 1-4 meters; chute can deploy from heights of 3-19 meters	SOLAS	Ask for references
SurvitecZodiac Medium Inflatable Slide System ( <b>MIS</b> )	High speed vessels requiring a relatively light-weight system such as fast ferries and catamarans	Lightest system available and can deploy from freeboard heights up to 12.5 meters	USCG, TC, SOLAS, EC/MED	Calmac Ferries, Conseil General de la Gironde, French Navy, Marine Nationale, Norled, Owen Sound Transportation, Russian Navy, Ven Trafikken
RFD Marin Ark	Large vessels with high freeboard decks, ferries naval vessels and world leading ships of the cruise industry	High degree of functionality, twin chutes with fewer liferafts, requires minimal crew to activate and can deploy from up to 28 meters	USCG, TC, SOLAS, EC/MED	Atlantic Marine, BC Ferries, Celebrity Cruises, Danish Navy, PAU Cruises, Princess Cruises, RCCL Cruises, Royal Australian Navy, Spanish Navy, Stena Line, STQ, U.K. Navy, U.S. Navy
DBC Vertical Chute	Very large vessels with high evacuation points such as cruise ships, high freeboard ferries and naval vessels	Most established technology (vertical chute) with many years of success and can deploy from up to 33 meters	USCG, TC, SOLAS, EC/MED	Alaska Marine Highway Systems, Anek Lines, Blackball Ferries, Brittany Ferries, Comanav, Conseil General, Delaware River and Bay Authority, Jadrolinja, Norwegian Cruise Lines, Star Cruises, Titan Cruises, UK Navy, Wightlink Ferries

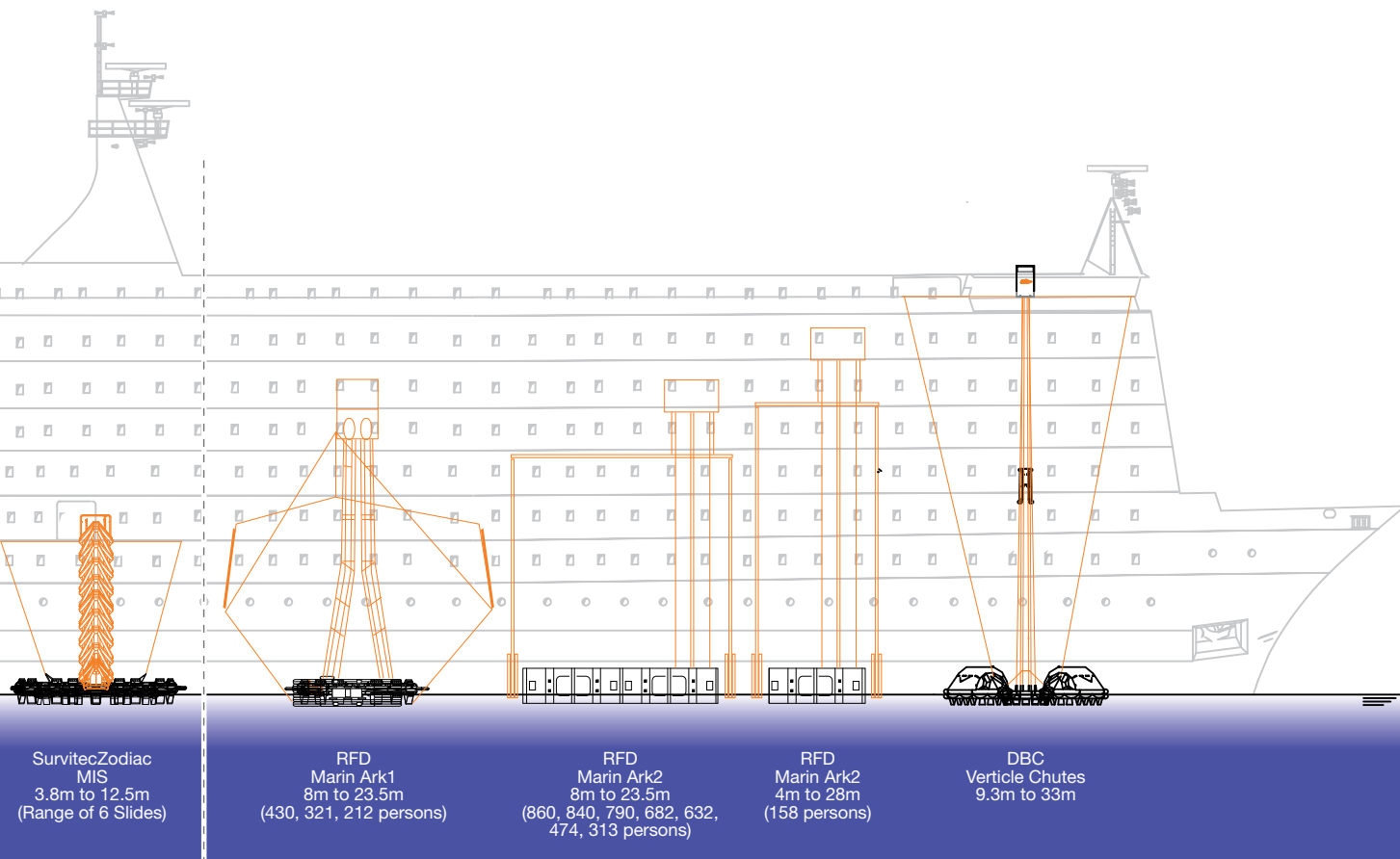

SurvitecZodiac MIS  
3.8m to 12.5m  
(Range of 6 Slides)

RFD  
Marin Ark1  
8m to 23.5m  
(430, 321, 212 persons)

RFD  
Marin Ark2  
8m to 23.5m  
(860, 840, 790, 682, 632, 474, 313 persons)

RFD  
Marin Ark2  
4m to 28m  
(158 persons)

DBC  
Vertical Chutes  
9.3m to 33m



# LOW FREEBOARD MES (UP TO 3.8M) SMALL INFLATABLE SLIDE (SIS)

Suitable for vessels with 1.5 to 3.8 meter freeboard

SOLAS Approved for use on IMO HSC as well as small passenger vessels



Contact us to learn more about pricing and ordering

The SIS Marine Evacuation System consists of a mini slide and liferaft/IBA. The slide is stored in an individual bag near the evacuation station. The liferaft is stored in its round container, generally on a different deck. The liferafts are launched remotely, inflated and bowsed into position using either manual or automatic electric winches. A mini slide is then inflated and deployed into the liferaft. Evacuees depart the vessel down the slide and into the liferaft.



### PNEUMATIC RELEASE SYSTEM



### ELECTRIC RELEASE SYSTEM



### ROUND CONTAINERS WITH LIGHTWEIGHT RAFT



### BOWSING ARRANGEMENT

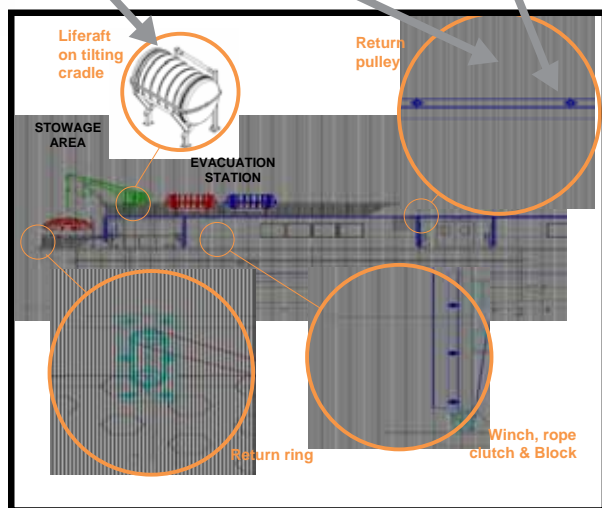

### DEMONSTRATION OF DEPLOYMENT SEQUENCE



### SLIDE



## LOW FREEBOARD MES (UP TO 3.8M) EVACUATION SLIDE SYSTEM (ESS)



The Evacuation Slide System is a 50-150 person capacity IBA packed together with a mini slide in a unique stowage container which is integrated into the ship's bulwark or side rails. When deployment is initiated the IBA inflates, and the mini slide is automatically inflated into the IBA. Once inflated, the IBA is bowsed to the ship's side and is then ready for the evacuation to commence. The ESS is handicap accessible for physically disabled persons.

Approved for use on IMO High Speed Craft as well as small passenger vessels

Suitable for vessels with 1.5 to 3.8 meter freeboard



Contact us to learn more about pricing and ordering

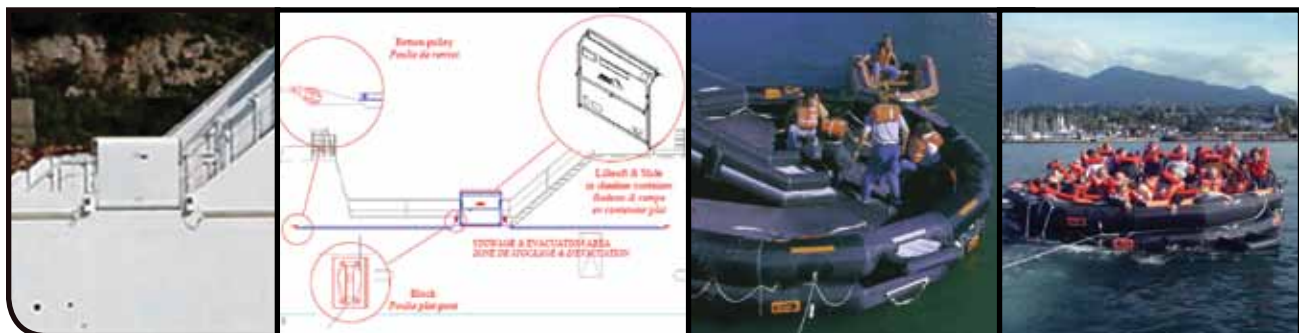

## LOW FREEBOARD MES (UP TO 3.8M) EVACUATION SLIDE SYSTEM (ESS)



The SurvitecZodiac version of ESS offers an optional automatic deployment system, in which the captain has a control box unit located in the wheelhouse for each system installed on the vessel.



1. Captain presses the button of the remote release unit
2. The ERU is activated and releases the lashing
3. The release of the lashing initiates the inflation of the airbag which pushes the box overboard
4. The platform and slide inflate automatically at the drop

5. The winches start 15 seconds after the button has been pressed, and stop when the bowing lines are in tension with 100 kg load
6. The first passenger or crew member removes the door locking pin and pushes the door open; evacuation starts



Contact us to learn more about pricing and ordering



## LOW FREEBOARD MES (UP TO 7M) MARIN ARK 109 SOLAS

Smaller operators want the peace of mind of knowing they too have the safest and most effective evacuation system on board. The RFD Marin Ark 109 is the logical choice for smaller numbers of passengers at lower freeboards.

Using one RFD Marin Ark liferaft together with a slide, the RFD Marin Ark 109 MES can be launched, inflated and bowsed in 145 seconds with a capacity to evacuate 109 passengers in 15 minutes. The versatility of the liferaft design allows for deployment without a slide for very low embarkation heights, or together with two alternative slide configurations for freeboard heights up to 23 feet.



Fully reversible, ensuring the system inflates upright each and every time  
Designed for open deck and between deck evacuations

Multiple slide configurations available to suit lower freeboard heights up to 23 feet



Contact us to learn more about pricing and ordering



## LOW FREEBOARD MES (UP TO 4.0M) MES SLIDE



The Brude MES Slide System is designed for HSC catamarans and ferries, with capacity ranging from 50 to 450 persons on one slide. The slide is activated and manned manually, and all operations can be carried out by a single crewmember. The components of the system include the evacuation slide and mooring system.

Approved for use on IMO High Speed Craft as well as small passenger vessels

Suitable for vessels with 1.0 to 4.0 meter freeboard

Refit is easy

IBA/ORIL/Platform Liferaft capacities of 50-300 persons

Self-righting Liferaft (with canopy) capacities of 100-450 persons

Complete flexibility for use of the slide and liferafts with 20% list



Contact us to learn more about pricing and ordering

## MEDIUM FREEBOARD MES (UP TO 19M) MES CHUTE



The Brude MES Chute System is designed to allow an efficient and safe evacuation of passengers on vessels in sea area up to D. The slide is activated and manned manually, and all operations can be carried out by a single crewmember. The components of the system include the evacuation chute and mooring system.

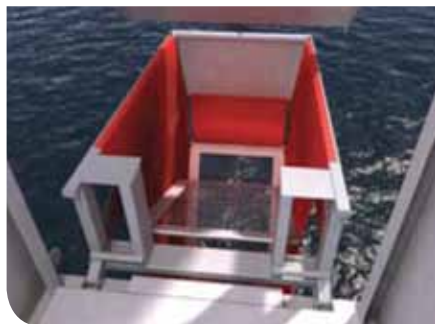

Approved for use on IMO High Speed Craft as well as small passenger vessels

Suitable for vessels with 3.0 to 19.0 meter freeboard

Refit is easy

IBA/ORIL/Platform Liferaft capacities of 100-300 persons

Self-righting Liferaft (with canopy) capacities of 150-450 persons

Complete flexibility for use of the slide and liferafts with 20% list



Contact us to learn more about pricing and ordering



## MEDIUM FREEBOARD MES (UP TO 12.5M) MEDIUM INFLATABLE SLIDE (MIS)



The MIS system is a twin track inflatable slide system available for freeboard heights up to 12.5 meters. It deploys at a right angle to the vessel and the slide is packed together with either a 100/150 person liferaft or two 100/151 person IBAs. This allows the liferaft/IBA to be available immediately for boarding after it is deployed and bowsed. Additional liferafts/IBAs are available to be bowsed to the primary system, depending on vessel capacity required.

MIS can evacuate 731 persons in 30 minutes for SOLAS passenger ship requirements

MIS can evacuate 397 persons in 17min 40sec for High Speed Code (HSC) requirements

4 slide lengths to cover vessel freeboard heights up to 12.5 meters

Range of liferafts (throw-over self-righting, throw-over or IBA) large capacity equipped with Venturi aspirators (using fewer gas cylinders and saving significant weight)

Flexible installation for closed deck and open deck vessels

Approved via heavy weather sea trials, with Beaufort 6 wind conditions and minimum 3 meters significant waves

Electric remote release system which automatically performs a complete system test

Float-free system operates before the water reaches the evacuation deck

Reduced crew requirements for operation and easy to operate

Simple and quick to install and re-install after service.

Push-button system deployment and detachment of slide from raft

Additional liferafts stored close to slide location in separate cradles

**SG**  
**VN** Contact us to learn more about pricing and ordering



**DEPLOYMENT PANEL FOR ACTIVATING MIS SYSTEM FROM EVACUATION STATION OR VESSEL BRIDGE**

Installation of the Medium Height Inflatable Slide system can be provided between two decks or in an open deck area according to the available space on the ship. Each installation style shown below in diagrams and photos.

**BETWEEN DECKS**



**OPEN DECK**



**DIAGRAM OF ENCLOSED INSTALLATION**

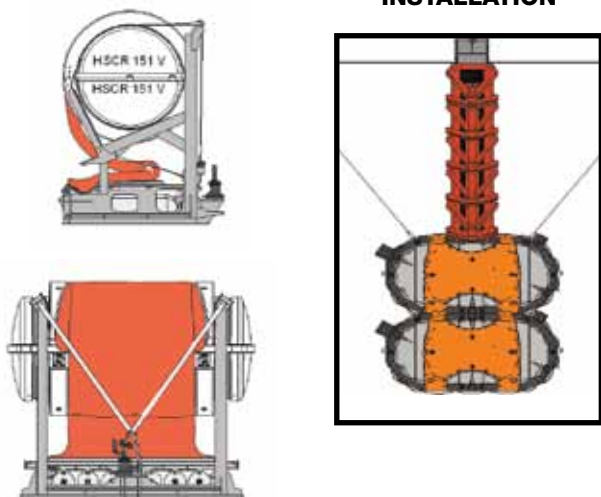

**BETWEEN DECK HOUSING SYSTEM**



**DIAGRAM OF OPEN DECK INSTALLATION**

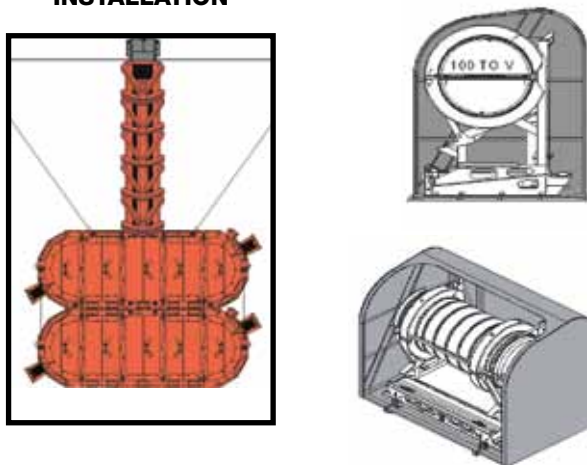

**OPEN DECK HOUSING SYSTEM**





## HIGH FREEBOARD MES (UP TO 28M) MARIN ARK2 SOLAS

The RFD Marin Ark2 are among the largest dry shod Marine Evacuation Systems in the world.

Each MES offers unparalleled safety coupled with value for money. All models feature a suspended floor to provide maximum thermal protection and multiple buoyancy compartments to ensure utmost safety in the toughest sea conditions.

The innovative helical slide path integrates the benefits of a fully enclosed evacuation chute with the natural descent of a spiral slide - crew members can even ascend to assist other passengers if required.

One of the most dynamic design features of this system is the integration of a service winch into the stowage unit which allows for the entire unit to be deposited onto a tug or truck during service periods thus in most cases eliminating the requirement for a crane during service.

Already accepted by the leading names in the industry, the Marin Ark2 sets new standards for Marine Evacuation Systems.



Available in 158, 316, 474, 632, 682, 790, 840 and 860 passenger configurations

Fully reversible liferafts ensure the system inflates upright each and every time

Unique modular design with suspended floor ensures maximum thermal protection for survivors

Dual spiral slide path allows for safe, rapid and controlled descent

Unique slide path design allows for crew ascent where necessary

Integrated service winch eliminates the need for crane hire during MES installation and service removal

Approved for open and between deck applications

Flexible design allows for installation on the widest range of vessel configurations

Compact all-in-one stowage design requiring minimal deck footprint

Revolutionary bowing system and evacuation slide path designed to meet the challenges of the latest modern wide beam vessels

Single action release for simple crew operation



Contact us to learn more about pricing and ordering



## HIGH FREEBOARD MES (UP TO 28M) MARIN ARK1 SOLAS



The RFD Marin Ark1 is among the world's safest and fastest method of transferring passengers and crew from a vessel into liferafts. In the case of an emergency, no other system is as efficient or effective. One simple release action activates the deployment of the system, which is fully inflated and operational within 90 seconds of deployment.

The liferafts are fully reversible, ensuring RFD Marin Ark1 inflates upright each and every time, and evacuation chutes are fully enclosed ensuring no passenger is exposed to the elements at any time during evacuation. Once deployed, the system is uniquely designed to ensure utmost stability in even the toughest sea conditions.



Available in 430, 321 and 212 passenger capacities

Fully reversible, ensuring the system inflates upright each and every time

Evacuation chutes are fully enclosed ensuring no passenger is exposed to the elements at any time during evacuation

Compact all-in-one stowage design requiring minimal deck footprint, maximizing space for passenger entertainment and comfort onboard

Stowage design allows for easy system 'swap-out' during service, meaning minimal vessel downtime

No additional bowing required during deployment

Available in symmetrical and asymmetrical options, enabling maximum design flexibility

Tween deck and open deck stowage solutions also available



Contact us to learn more about pricing and ordering



## HIGH FREEBOARD MES (UP TO 33M) VERTICAL CHUTES

The DBC Chute system is available for freeboard height installations up to 108 feet. The system comprises of a vertical chute with a platform at the base. Throw Over liferafts are connected via an interface to the receiving platform.

The chute and platform are contained in a housing on the evacuation deck. A simple pull handle automatically deploys the chute and inflates the receiving platform. Passengers and crew simply jump into the chute and their vertical descent is controlled via the engineered vertical descent control mechanism (Zig-Zag system).

DBC Vertical Chutes are the Survitec Group MES with the highest evacuation height available: up to 33 meters

Most well-established technology for rapid evacuation of very large passenger vessels



Contact us to learn more  
about pricing and ordering



## MARINE EVACUATION FOR OFFSHORE

Emergency evacuations from an offshore facility can arise due to many causes and under a range of diverse and dangerous circumstances, not all of which can be foreseen. A key objective is to avoid significant incidents escalating into major incidents. To achieve this goal, emergency evacuations require integrated, cross-discipline coordination and a portfolio of evacuation options.

Emergency evacuation from an oil and gas rig is primarily via a davit or free-fall lifeboat. However, in order to make provisions for personnel who cannot access the lifeboats during an emergency, an alternative secondary means of evacuation is traditionally provided. Injuries and fatalities associated with traditional means of secondary evacuation have seen a rapid increase over the years, due to the significantly higher elevations of oil and gas facility decks (80-120ft).





## OFFSHORE EVACUATION (UP TO 80M) MASS EVACUATION SYSTEM

The Survitec Offshore Mass Evacuation System has been designed specifically to address hazards associated with these more 'traditional' approaches to secondary evacuation.

The fully enclosed, deck mounted system is suitable for operating heights of up to 75-80 meters and provides a protected means of evacuation from an offshore facility. The system can move a maximum of 150 personnel from topsides down to sea level via a fire and smoke protected vertical, telescoping, escape chute directly into a single SOLAS rated high capacity liferaft within 10 minutes of deployment.

The life raft is connected to the chute and stabilization system by means of an integrated breakaway landing platform which can be disconnected from the liferaft once personnel have boarded enabling the raft to move away from the hazard. The system design ensures that the breakaway landing platform, chute and stabilization system remain in place and are able to be recovered to the deck for re-use.

The system can be configured for use with 50, 70, 75, 100, or 150 man liferafts and is intended to be used primarily as a reliable, alternative means of evacuation when the main lifeboats are impaired or inaccessible.

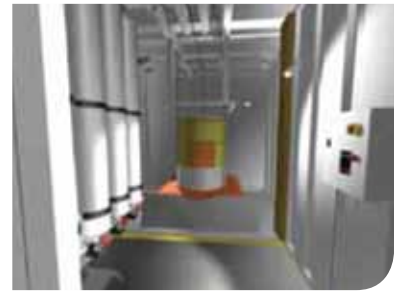

Bolt down Skid Frame with over-side cantilever section

Skid frame mounted container with rear door access and hazard resistant outer cladding

Internal structural support frame bolted to the container supporting pneumatic winch, cables & pulley system & escape chute

Internal Explosion proof lighting system rated for hazardous area use (Classification Zone I Div 1 Class I)

Gravity Braked winch with hydraulic motor and accumulators with capacity as necessary to recover the system twice (two cycles)

Three wire cable and pulley system connected to the winch drum and terminating at the tensioning cans

Vertical Kevlar telescoping 'Escape Chute' with fire & smoke resistant outer cover, stainless steel reinforcing rings and high tensile strength Kevlar connecting cables

High capacity SOLAS approved life raft with integrated buoyant breakaway landing platform configurable to enable the liferaft to freely rotate around the landing platform by means of a hoop/bearing assembly

Open grid lightweight support frame for storing the liferaft in the stowed condition

Cable tensioning

**SG HS** Contact us to learn more about pricing and ordering

# SOLAS RESCUE & WORKBOATS

Rigid Inflatable Boats	301
Rescue & Workboats	302
Rigid Rescue Boats	303 - 304



# RIGID INFLATABLE BOATS

All SurvitecZodiac Rescue Boats are SOLAS approved.

The RIBO 450 is a 4.5m six person boat can be launched using a 4 point sling and approved release hook – SWL > 950kg & < 1.5 tonne.

The RIBO 600 is a 6.0m self righting boat. It can be sling launched using an appropriate release hook (SWL > 1500Kg). This boat features a wheel console with jockey seat, two further jockey seats, additional seating for two further passengers and additional space for a full stretcher.

The FRB 600 is distinguished from the RIBO 600 by the addition of a single point lifting frame. It is delivered supplied with a 70hp SOLAS approved outboard motor as standard and is further fitted with two 70 liter fuel tanks.

BOAT MODEL / CAPACITY	APPROVALS	*WEIGHT WITH EQUIPMENT AND BATTERIES	PRODUCT #	SGVN
RIBO 340 4 Person		300 Lbs. (136kg)	DRZ34007	
RIBO 450 6 Person	EC / SOLAS	543 Lbs. (246kg)	DRZ34008	
RIBO 450 6 Person	USCG / SOLAS	468 Lbs. (212kg)	DRZ34010	
RIBO 600 6 Person	SOLAS	1089 Lbs. (494kg)	DRZ34014	
FRB 600E 6 Person	SOLAS	1543 Lbs. (700kg)	DRZ34015	



\* WEIGHT DOES NOT INCLUDE ENGINE, FUEL OR PASSENGERS. CONTACT US FOR AVAILABLE APPROVED ENGINES BOAT SIZE

**FRB 600E**





# RESCUE AND WORKBOATS

Survitec Group offers a full range of rescue and workboats. These include DSB Fast Rescue Boats developed and tested in accordance with the latest SOLAS/IMO regulations; DSB Small Inflatable Rescue Boats manufactured from ultra light Hypalon fabric making them safe, strong, easy to handle and ideal for the Rescue Services; and DSB Semi Rigid Rescue Boats which combine an aluminium hull with an inflatable upper section giving improved performance with extra strength and reduced maintenance.



IRB MODEL/ CAPACITY	APPROVALS	L X BEAM DIMS	WEIGHT	PRODUCT #	SG VN
420 IRB 6 Person	MED/ SOLAS	13.8' x 5.9' (4.20x1.80m)	243 Lbs. (110kg)	Call	
470 IRB 7 Person	MED/ SOLAS	15.5' x 6.5' (4.70x1.98m)	243 Lbs. (110kg)	Call	
530 IRB 15 Person	MED/ SOLAS	17.4' x 7.1' (5.30x2.15m)	375 Lbs. (170kg)	Call	

SR MODEL/ CAPACITY	APPROVALS	L X H X W DIMS	WEIGHT	PRODUCT #	SG VN
3.9 SR 4 Person	SOLAS	12.8' x 6.4' (3.90x1.95m)	289 Lbs. (131kg)	Call	
4.3 SR 6 Person	SOLAS	14.2' x 6.4' (4.30x1.95m)	430 Lbs. (195kg)	Call	
5.1 SR 14 Person	SOLAS	16.8' x 6.8' (5.10x2.05m)	552 Lbs. (250kg)	Call	
6.5 SR * 14 Person	SOLAS	21.3' x 8.3' (6.50x2.50m)	684 Lbs. (310kg)	Call	

\* 6.5 SR IS ALSO AVAILABLE IN FAST BOAT SPECIFICATION. TECHNICAL DATA IS ONLY APPROXIMATE AND SUBJECT TO SLIGHT VARIATION.

## Inflatable Rescue Boats

The DSB420 IRB is MED approved and can be supplied with or without a release hook. A long shaft engine with a maximum 30hp is recommended for use with this boat, providing enough power to tow a 100 person liferaft if required. All new boats will be delivered to a vessel assembled, fully inflated and tested. Each Rescue Boat is supplied with a fully approved equipment pack. Also available in 4.7m (7 persons) and 5.3m (15 persons).

## Semi Rigid Inflatable Boats

The Semi Rigid Rescue Boat combines an aluminium hull with an inflatable upper section offering improved performance with extra strength and reduced maintenance. The size range for the Semi Rigid Rescue Boats being 7-15 persons makes them also suitable as a workboat. Available in 3.9m (6 persons), 4.3m (8 persons), 5.1m, (13 persons) and 6.5m (14 persons)

## Workboats

Originally developed for military use, the DSB General Purpose Inflatable Workboats are highly robust and ideal for use as safety boats, water rescue boats, diving boats or workboats and have proven durable and versatile in the most adverse conditions.



# RIGID RESCUE BOATS

Sea-water resistant aluminum hull with water tight compartments.

Easy inspection, maintenance and repair with ready access to servicing points

No use of expanded foam in the hull results in lower overall weight, no water absorption or inside corrosion and no fungal/pest growth

High quality propulsion system

Built for operation in Arctic conditions

Green passport

Davit delivered upon request

Designed and tested according to the LSA Code and IMO Res. MSC.81.(70) MED approved

NORSOK approved (option)

The Brude HD 720 ASI is a rescue boat designed and manufactured according to latest SOLAS, Classification Society and National Authority requirements. This fast rescue boat has excellent reliability, maneuverability and sea-keeping ability so that it can fulfill its prime function - to provide an effective means of search and recovery for persons missing at sea. The lay out and performance of the boat allow it to perform other roles as well, including dive support, inspection, patrol, survey and work boat duties.



**HD 720 ASI**



BOAT MODEL	CAPACITY	L X W DIMS	EMPTY WEIGHT	MAX WEIGHT	PRODUCT #	SGVN
HD 720 ASI	6-15 persons	23.6' x 7.9' (7.20x2.40m)	4167 Lbs. (1890kg)	6647 Lbs. (3015kg)	Call	





# RIGID RESCUE BOATS

Fast RSQ boats are built for the most demanding users, who require a rigid craft with high quality/safety standards, competitive pricing, and low cost of ownership.



**FRSQ 600 A**



**FRSQ 700 A**



**FRSQ 850 A**

**FRSQ 600 A**

-----

Features deep V-bottom hull construction

Hull made of seawater-resistant aluminum

Craft can be safely launched and retrieved under adverse weather and sea conditions

Rubber fender

-----

> 20 knot speed with 3 persons

-----

**FRSQ 700 A and FRSQ 850A**

-----

Keel is longer in the direction of the bow providing a “split bow” effect for excellent manoeuvring stability

Hull made of seawater-resistant aluminum

-----

The fender is made up out of 5 separate blocks which can be easily removed by one person within short period of time, even when in use offshore.

-----

BOAT MODEL	CAPACITY	L X W DIMS	EMPTY WEIGHT	MAX WEIGHT	PRODUCT #	SG VN
RSQ 450 A	6 person	16.0' x 5.8' (4.88x1.75m)	1026 Lbs. (465kg)	2117 Lbs. (960kg)	Call	
RSQ 475 A	6 person	16.1' x 7.4' (4.90x2.25m)	2315 Lbs. (1050kg)	3407 Lbs. (1545kg)	Call	
FRSQ 600 A	15 person	20.1' x 7.4' (6.11x2.26m)	4167 Lbs. (1890kg)	6897 Lbs. (3128kg)	Call	
FRSQ 700 A	15 Person	23.8' x 8.8' (7.22x2.65m)	4630 Lbs. (2100kg)	7360 Lbs. (3338kg)	Call	
FRSQ 850 A	21 Person	27.9' x 10.2' (8.50x3.08m)	7827 Lbs. (3550kg)	10556 Lbs. (4788kg)	Call	

RIGID RESCUE BOAT MODELS SHOWN WITH ALUMINUM HULLS. ASK FOR SPECIFICATION AND AVAILABILITY FOR GRP/FIBERGLASS HULL MODELS.

THIS PAGE INTENTIONALLY LEFT BLANK

# DAVITS

Choosing The Right One	401
Liferaft Davit	402
Rescue Boat Slewing Davit	403
Fast Rescue Boat Davit	404
Release Hook	405



# CHOOSING THE RIGHT ONE: DAVIT

Survitec Group offers a wide variety of davit and crane products for the commercial marine and offshore sectors. This product range is renowned for easy installation, operation and cost-effectiveness. We recommend you consult your Sales Manager to discuss all particular

aspects of your application for considerations and a product recommendation.

**SGVN** Please contact us for additional product, pricing and ordering information.



Rescue Boat Slewing



Fast Rescue Boat



Liferaft



Combi Rescue Boat/Liferaft



Daughter Craft/Workboat

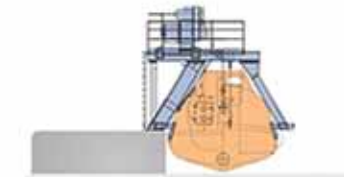

Offshore



Lifeboat



Free-Fall



Fender



Overhead Telescopic



Yachting



Accessories



Fixed Boom



Knuckle Boom



Telescopic Boom

# LIFERAFT DAVIT



**SCM 21-4.0 LIFERAFT DAVIT**

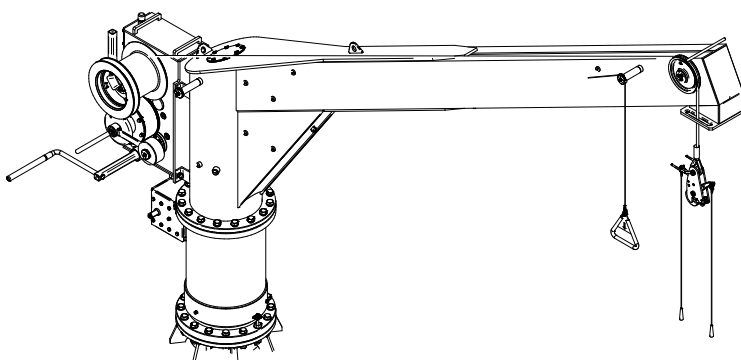

This manual, freestanding, deck-mounted davit has been designed for long time operation under adverse and extreme conditions in a highly corrosive marine environment. The system is suitable for safe and efficient launching of a fully manned liferaft against unfavorable conditions of trim of up to 10 degrees and a list of up to 20 degrees either way.

It is considered a “plug-in and play unit” renowned for easy installation on board. The davit arm is manually slewed by turning the crank handle, and when the correct outboard position has been achieved, the liferaft can be inflated.

After embarking, the liferaft can be lowered to the water level. The lowering procedure can be controlled in two ways, either by means of a remote control wire from within the liferaft or by lifting the brake handle of the winch directly. Lowering is driven by gravity.

The empty hook can be recovered manually using the crank handle of the winch. Dependant on the lowering height and the number of liferafts, the winch can be equipped with a so-called “quick-return unit” for easy and fast retrieval of the empty hook.

Compatible with Survitec Group davit launch liferafts (all brands) for capacities of 12 - 25 persons

Compact design with minimum height, width and length (only 4.0 meter radius)

Small footprint, for easy installation onboard

Meets the latest IMO/ SOLAS requirements, LSA Code and MED approval

Delivered as one complete pre-assembled and tested davit system (davit arm, column and winch) ready for immediate use

24kN safe working load

Stainless steel for all shafts, piping and bolts and nuts up to M16

Relatively low davit weight and low deck forces

Easy access for periodic maintenance, service and repair, support by with clear labeling and detailed manuals

Light weight aluminium version available on request

Contact us to learn more about pricing and ordering



# PALFINGER NED-DECK

## RESCUE BOAT SLEWING DAVIT

This freestanding, hydraulic slewing davit has been designed for long time operation under adverse and extreme conditions in a highly corrosive marine environment. The system is suitable for safe and efficient launching and recovery of a fully manned rescue boat against unfavorable conditions of trim of up to 10 degrees and a list of up to 20 degrees either way.

It is considered a “plug-in and play unit” and renowned for easy installation on board. The davit arm slews the rescue boat from its stowed position into launch position using a self-containing hydraulic power pack unit. The slewing motion is actuated from within the rescue boat by means of a remote control pull wire.

The lowering motion can be controlled in two ways, either by means of a remote control pull wire from within the rescue boat or by lifting the brake handle of the winch directly. Lowering is driven by gravity.

Recovery of the rescue boat with its crew is realised by using the electric driven winch. In case of a power failure or malfunctioning of the electric system, hoisting can also be done manually by using the crank handle of the winch.



SCH 12-3.5 RESCUE BOAT DAVIT

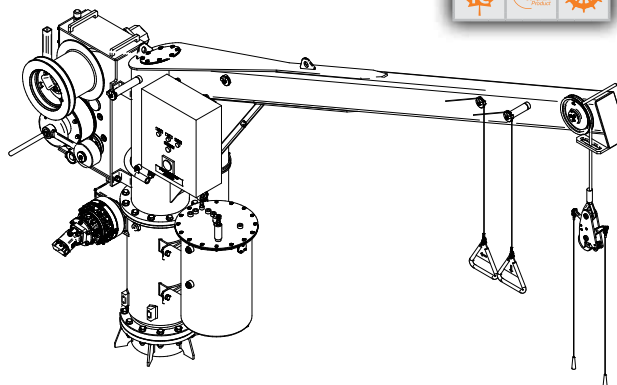

Since the safe working load and outreach of the davit are normally determined by the size of the rescue boat, check with your Sales Manager on the specific product application you are considering

Compact design with minimum height, width and length (only 3.5 meter radius)

Small footprint, for easy installation onboard

Meets the latest IMO/ SOLAS requirements, LSA Code and MED approval

Delivered as one complete pre-assembled and tested davit system (davit arm, column, winch and built-on hydraulic power pack unit) ready for immediate use

12kN safe working load

Stainless steel for all shafts, piping and bolts and nuts up to M16

Relatively low davit weight and low deck forces

Easy access for periodic maintenance, service and repair, support by with clear labeling and detailed manuals

Light weight aluminium version available on request

Contact us to learn more about pricing and ordering



# FAST RESCUE BOAT DAVIT



This freestanding, hydraulic pivoting davit has been designed for long time operation under adverse and extreme conditions in a highly corrosive marine environment. The system is suitable for safe and efficient launching and recovery of a fully manned rescue boat against unfavorable conditions of trim of up to 10 degrees and a list of up to 20 degrees either way.

It is considered a “plug-in and play unit” and renowned for easy installation on board. The davit arm pivots the rescue boat from its stowed position into launch position using a self-containing hydraulic power pack unit. The slewing motion is actuated from within the rescue boat by means of a remote control pull wire.

The lowering motion can be controlled in two ways, either by means of a remote control pull wire from within the rescue boat or by lifting the brake handle of the winch directly. Lowering is driven by gravity.

Recovery of the rescue boat with its crew is realised by using the electric driven winch. In case of a power failure or malfunctioning of the electric system, hoisting can also be done manually by using the crank handle of the winch.

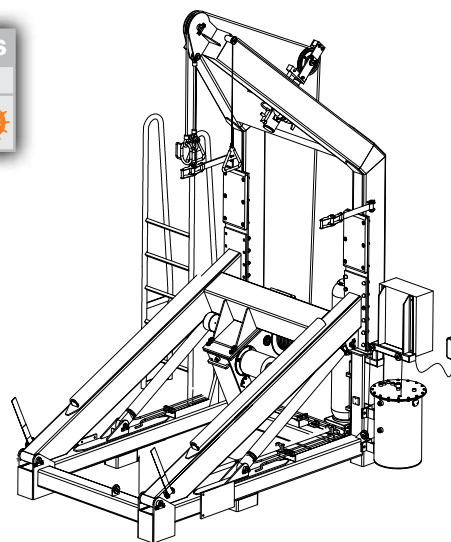

**PRHE 30 RESCUE BOAT DAVIT**

Since the safe working load and outreach of the davit are normally determined by the size of the rescue boat, check with your Sales Manager on the specific product application you are considering

Meets the latest IMO/SOLAS requirements, LSA Code and MED approval

Compact design with minimum height, width and length

Small footprint, for easy installation onboard

Delivered as one complete pre-assembled and tested davit system (davit arm, column, winch and built-on hydraulic power pack unit) ready for immediate use

Stainless steel HPU (hydraulic power pack unit) critical components are covered in hydraulic oil

30kN safe working load

Stainless steel for all shafts, piping and bolts and nuts up to M12

Relatively low davit weight and low deck forces

Remote control push button box, for hoisting and emergency stop

Integrated boat cradle, complete with lashings

Shock absorber (hydraulic dampener) optional

Integrated outer support for (fast) rescue boat, optional

Easy access for periodic maintenance, service and repair, support by with clear labeling and detailed manuals

Light weight aluminium version available on request

**SGVN** Contact us to learn more about pricing and ordering

# PALFINGER NED-DECK

## CAR 35 RELEASE HOOK

As one of the only products of its type, this SOLAS approved Combined Automatic Release (CAR) Hook is specially designed to handle rescue boats and liferafts up to a Safe Working Load of 3.500 kg (± 7716 lbs). It is known as the preminent automatic release hook for rescue boat or liferaft handling.

With a proven track record since 2000, the CAR35 is a reliable, user-friendly, safe, must-have accessory for your davits.

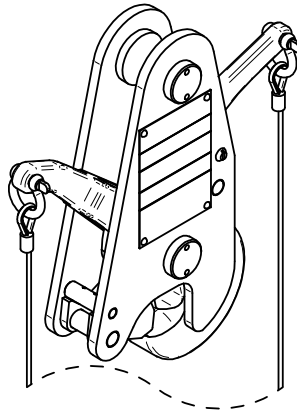

99% stainless steel resulting in low maintenance cost

Combination of high quality and economical pricing - one hook for two applications, which is easy to use

When deploying a rescue boat the crew only need to operate one (1) hook resulting in safer and more expedient operation

Weight of approximately 7.5 kg

**SG** Contact us to learn more about  
**VN** pricing and ordering

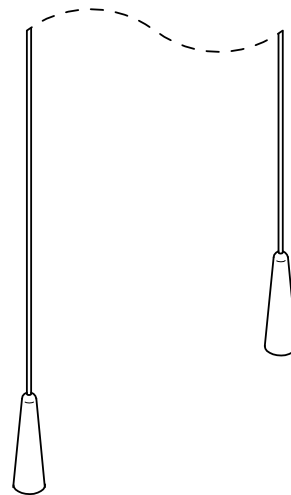



# PYROTECHNICS

Kits	501 - 502
Flares & Smokes	502 - 503
Rockets & Line Thrower	504
Containers	505





### SHIP'S BRIDGE DISTRESS KIT

SG  
JV

12 Parachute Red Rockets  
Includes Large Poly Bottle

Ship's Bridge Distress Kit  
product # 30-2002



### RORC/USYRU DISTRESS KIT

SG  
JV

4 Red Hand Flares  
4 White Collision Flares  
4 Parachute Red Rockets  
2 Lifesmokes

Includes Large Poly Bottle  
RORC/USYRU Distress Kit  
product # 50-RORC-2395



### LIFEBOAT DISTRESS KIT

SG  
JV

6 Red Hand Flares  
4 Parachute Red Rockets  
2 Lifesmokes

Includes Large Poly Bottle  
Lifeboat Distress Kit  
product # 30-2052



### OFFSHORE DISTRESS KIT

SG  
JV

4 Red Hand Flares  
4 Parachute Red Rockets  
2 Lifesmokes

Includes Large Poly Bottle  
Offshore Distress Kit  
product # 30-55590





SG  
JV

## OVER 50-MILE DISTRESS KIT

PainsWessex

6 Red Hand Flares  
3 Parachute Red Rockets  
3 Lifesmokes

Includes Large Ammo Tin  
Over 50 Mile Distress Kit  
product # **50-MDS-1**



SG  
JV

## PERSONAL DISTRESS SIGNALS MINIFLARE MK8

PainsWessex

Lightweight compact pack containing 9 red aerial flare cartridges and a penjector ignition

Penjector firing mechanism is fitted with a stainless steel spring and striker pin in a tough, water resistant case

Min. 5 second burn time per flare with min. 10,000 candela light intensity  
150 ft. firing height

-22°F to 149°F operating temperature range and -22°F to 167°F storage temperature range  
Personal Distress Kit product # **30-55665**



SG  
JV

## RED HANDFLARE MK8

PainsWessex

Telescopic handle allows easy extension for safe operation and saves space in stowage  
Top pull-wire igniter

For use day or night to pinpoint position  
Min. 60 second burn time with min. 15,000 candela light intensity

-22°F to 149°F operating temperature range and -22°F to 167°F storage temperature range  
Red Handflare Mk8 product # **30-52900**



SG  
JV

## WHITE HANDFLARE MK8

PainsWessex

Telescopic handle allows easy extension for safe operation and saves space in stowage  
For use day or night as a collision warning signal

Top pull-wire igniter  
Min. 60 second burn time with min. 2,500 candela light intensity

-22°F to 149°F operating temperature range and -22°F to 167°F storage temperature range  
White Handflare Mk8 product # **30-52751**



## DAY/NIGHT SIGNAL MK8



Compact hand-held distress signal consisting of a red flare at one end and orange smoke at the other

Dense orange smoke for min. 18 seconds and red flare for min. 20 seconds

For day or night use to pinpoint position

-22°F to 149°F operating temperature range and  
-22°F to 167°F storage temperature range

Rugged, corrosion and water resistant case housing with pull toggle application ignition

Day/Night Signal product # **30-55970**



## LIFESMOKE MK8



Compact, flat-top day-time orange smoke distress signal providing effective position marking or indication of wind direction during rescue operations

Pull-wire ignition with a 2 second safety delay... just pull and drop in the water

Dense orange smoke for min. 3 minutes

-30°F to 86°F operating temperature range and  
-22°F to 167°F storage temperature range

Lifesmoke product # **30-53685**



## MANOVBORBOARD MK8/ BUOYSMOKE MK8



Manoverboard is combined light and smoke lifebuoy marker which far exceeds SOLAS/MED requirements

Should be attached to a lifebuoy and used in emergency to mark position of manoverboard

Buysmoke is same as manoverboard, but without lights and for day use only

Firing pin/percussion cap ignition

Dense orange smoke min. 15 minutes burn time and min. 2 Candela light intensity for 2 hours

-30°F to 86°F operating temperature range and  
-22°F to 167°F storage temperature range

Manoverboard product # **30-53775**

Buysmoke product # **30-53830**



## PARACHUTE RED ROCKET MK8A



Designed to withstand exceptional environmental exposure and to perform reliably even after immersion in water

Base pull-wire ignition and 300 ft. firing height

Min. 40 second burn time with min. 30,000 candela light intensity

-22°F to 149°F operating temperature range and -22°F to 167°F storage temperature range

Features improved grip for easy handling and conforms to SOLAS 74/88 as amended

Para Red Rocket product # [30-50672](#)



## PARACHUTE ILLUMINATING ROCKET MK8



Used in search and rescue operations at night for collision warning

Designed to withstand exceptional environmental exposure and to perform reliably even after immersion in water

Rocket ejects a white flare at 984 feet which burns for a min. 30 seconds at min. 90,000 candela light intensity

Para Illuminating Rocket product # [30-50755](#)



## LINETHROWER 250



Self-contained single shot, line throwing appliance that is fully compliant to the latest international USCG and SOLAS/MED legislation

For use ship to shore, shore to ship, and ship to ship

Throwing range of a min. 750 ft. and line breaking strain of 2kN

-22°F to 149°F operating temperature range and -22°F to 167°F storage temperature range

Linethrower body only product # [30-50070](#)

Linethrower rocket only product # [30-50080](#)



**POLY BOTTLES**

SG  
JV

Rugged, buoyant containers, ideal for storing distress signals

Can be easily picked up in an emergency

12 liter large bottle product # 30-56800

3 liter mini bottle product # 30-9870050



**METAL BOXES FOR ROCKETS**

SG  
JV

Rugged and lightweight aluminum containers that meet shipping requirements and are ideal for storing rockets

Large Metal Box with Lid product # 30-PW5020



**AMMO TIN CONTAINERS**

SG  
JV

Rugged and heavy steel containers with hinged covers that meet shipping requirements and are ideal for storing rockets

Manufactured to mil-spec standard in olive drab color

Large Ammo Tin product # 10-35-0105-PA19

Medium Ammo Tin product # 10-35-0010-M2A1

Small Ammo Tin product # 10-35-0002-M19A



# PERSONAL FLOTATION

Choosing The Right One 601 - 602

Personal Flotation Devices 603 - 608

Inflatable Lifejackets 609 - 610

PFD Parts And Accessories 611 - 612

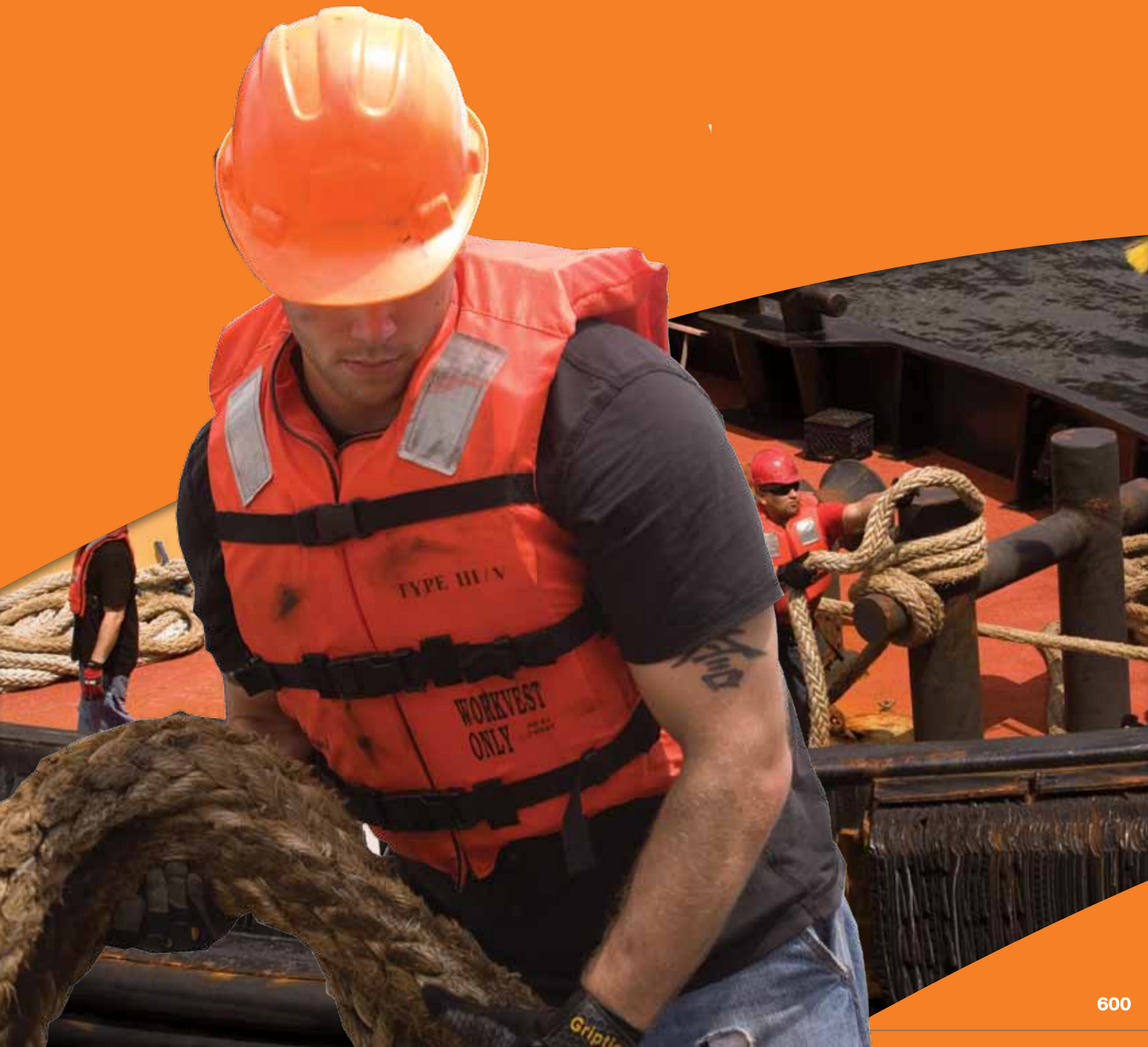

# CHOOSING THE RIGHT ONE: APPROVALS/SIZING

Personal Flotation Devices are tested and approved by legislative bodies with authority to regulate use and specifications. The two key organizations in North America who provide approvals are USCG and TC.

UNITED STATES COAST GUARD (USCG) APPROVAL	USCG Type Approval is required for lifejackets used aboard U.S. flagged vessels.			
	CLASSIFICATION	MIN. BUOYANCY	USAGE	ADVANTAGES
Type I	Inherently buoyant PFDs	11 Lbs. For Child 22 Lbs. For Adult	Off-shore, open or rough waters, coastal cruising, general boating	Best for all waters, will turn most unconscious wearers face up, highly visible coloring
	<b>Areas Of Use:</b> Ideal for cargo ships and cruise ships.			
Type II	Inherently buoyant and inflatable type II PFDs	15.5 Lbs.	Inland waters or calm waters where fast rescue is likely	Comfortable, turns some unconscious wearers face up in the water
	<b>Areas Of Use:</b> General boating.			
Type III	Inherently buoyant and inflatable type III PFDs	15.5 Lbs.	Inland waters or calm waters where fast rescue is likely	Generally the most comfort for continuous wear, many styles available
	<b>Areas Of Use:</b> Construction, general industrial laborers, commercial workers			
Type IV	Throwable device	18 Lbs.	For calm inland water with heavy boat traffic, where help is always nearby	Does not have to be worn, good back-up to PFDs
	<b>Areas Of Use:</b> All boats and vessels, recreational and commercial			
Type V	Inherently buoyant and inflatable type V PFDs	15.5 - 22 Lbs.	Special use - see PFD label, includes deck suits and workvests	Designed for specific activities
	<b>Areas Of Use:</b> Construction, general industrial laborers, commercial workers, public safety			

IMPERIAL SIZE	CHEST SIZE
XS/S	28" - 32"
S	32" - 36"
S/M	32" - 40"
M	36" - 40"
M/L	32" - 42"
L/XL	40" - 50"



IMPERIAL SIZE	CHEST SIZE
XL	45" - 50"
XL-2XL	42" - 58"
2XL	50" - 55"
2XL/3XL	50" - 60"
3XL	55" - 60"

IMPERIAL SIZE	CHEST SIZE
Workvest	32" - 54"
Adult Universal	30" - 52"
Adult Jumbo	38" - 60"
Adult Magnum	48" - 65"

IMPERIAL SIZE	USER WEIGHT
Infant	0 - 50 Lbs
Child	30 - 50 Lbs
Youth	50 - 90 Lbs
Commercial Child	Under 90 Lbs
Commercial Adult	Over 90 Lbs



## CHOOSING THE RIGHT ONE: BRAND

BRAND	DESCRIPTION AND KEY INDUSTRIES SERVED
	<p>The Imperial brand Immersion Suit is renowned as the highest quality, best value model on the commercial marine market, with a heritage spanning back to its creation in 1959. As the manufacturer and supplier of Imperial immersion suits, Survitec Group rebranded the legacy Safeguard line several years ago to Imperial. Over time, we have steadily gathered customer insight for important improvements to the Imperial brand flotation supporting commercial marine, public safety and commercial industries.</p>
	<p>With over five decades' activity in the leisure marine market, the Crewsaver brand is one of the most well-known in the industry. Developed and designed by water sport enthusiasts, this brand's products can be relied upon to consistently exceed the standards we have set for ourselves. This level of quality construction and proven success in high-performance environments makes Crewsaver PFD products well suited for the public safety sector.</p>
	<p>A premiere brand in the paddle and kayak marine market, Survitec Group recognized qualities within several Yak products which makes them good cross-over solutions to the public safety sector.</p>



## 160RT/161RT BASIC FERRY BOAT PFD

SG  
JV



Reversible yoke-style flotation device

Stackable for easy storage

110 square inches of SOLAS-grade reflective tape

Attachment loop on vest for optional light or whistle

160RT Adult product # [61-160RT-001](#)  
 161RT Child product # [61-161RT-001](#)

22”L x 12”W x 13”H Haddock Bag with Four 160RT PFDs product # [69-1024](#)



## 198RT/199RT BASIC OFFSHORE PFD

SG  
JV



The most comfortable type I PFD on the market

126 square inches of SOLAS-grade reflective tape

198RT Commercial Adult product # [61-198RT-001](#)  
 199RT Commercial Child product # [61-199RT-001](#)

198RT Replacement Snap part # [60-SNAP-DRING](#)



## 230RT DELUXE OFFSHORE PFD

SG  
JV

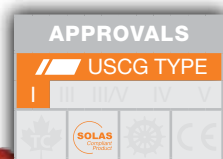

Fitted with a whistle and buddy line

Foldable and stackable for easy storage

110 square inches of SOLAS-grade reflective tape

Expands chest size with optional belt extender

230RT product # [61-230RT-001](#)  
 230RT Belt Extender part # [60-23078398](#)





**Crewsaver®**  
Safer By Design

SG  
JV

## PREMIER 2010 DELUXE OFFSHORE PFD



APPROVALS				
USCG TYPE				
I	III	III/V	IV	V

- Fitted with a whistle and buddy line
- 
- Foldable and stackable for easy storage
- 
- Self-rights a wearer at an average speed of 1.7 seconds
- 
- Expands chest size with optional belt extender
- 
- Available with optional lights
- 
- Premier 2010 Adult product # **61-10572**
- Premier 2010 Child product # **61-10573**
- Premier 2010 Infant product # **61-10574**
- 
- Premier 2010 Belt Extender part # **61-10600**



SG  
JV

## 2200 SERIES MESH WORK VESTS



APPROVALS				
USCG TYPE				
III	III/V	IV	V	

- For commercial and bridge working operations
- 
- Lightweight and durable mesh shoulders and back
- 
- Contoured foam panels and two front gusseted pockets
- 
- D-ring for gear attachment
- 
- Reflective striping
- 
- Heavy duty zipper
- 
- 2200 Captain's Mesh Vest**  
Two 1.5" encircling body belts
- 
- S/M product # **63-2200-001-SM**
- L/XL product # **63-2200-001-LX**
- 2XL/3XL product # **63-2200-001-23**
- 
- 2210 Commander's Mesh Vest**  
3M SOLAS-grade reflective tape, two side adjustments and two lash tabs on front panels - New Design for 2014
- 
- S/M product # **63-2210-001-SM**
- L/XL product # **63-2210-001-LX**
- 2XL/3XL product # **63-2210-001-23**
- 
- 2230 Admiral's Mesh Vest**  
3M SOLAS-grade reflective tape, rip-stop nylon, flotation-filled comfort collar, two 1.5" encircling body belts and one chest belt - New Design for 2014
- 
- S/M product # **63-2230-001-SM**
- L/XL product # **63-2230-001-LX**
- 2XL/3XL product # **63-2230-001-23**



## 320RT/321RT INDUSTRIAL ECONOMY VEST

SG  
JV



Perfect for commercial and industrial applications with snag-hazard environments  
 Large armholes, open sides, side adjustment tabs and heavy duty zipper  
 SOLAS-grade reflective tape  
 320RT L/XL product # 63-320RT-001-LX  
 320RT-4 L/XL (with 4 front gusseted pockets) product # 63-320RT4-01-07  
 321RT S/M product # 63-321RT-001-SM  
 321RT-4 S/M (with 4 front gusseted pockets) product # 63-321RT4-01-03



APPROVALS				
USCG TYPE				
III	II/V	IV	V	



## 775RT/778RT GENERAL PURPOSE INDUSTRIAL VEST

SG  
JV



Great for natural disaster relief or similar environmental incidents  
 Large armholes and open sides for maximum comfort  
 Two encircling body belts and one chest strap  
 SOLAS-grade reflective tape  
 775RT Adult Universal product # 63-775RT-001-AU  
 778RT Adult Magnum product # 63-778RT-001-AM



APPROVALS				
USCG TYPE				
III	II/V	IV	V	



SG JV

### 370ERV EMERGENCY RESPONSE VEST



APPROVALS				
USCG TYPE				
III	IV	V	VI	VII

Good for emergency first responders

100MPH impact test rated belts

31 sq inches of reflective tape on front and back

Rip-stop nylon fabric

High visibility day glow on pockets and collar

Two gusseted pockets

Flotation-filled comfort collar

Light attachment point on both shoulders

Lash tabs

Adjustable leg straps

S/M product #: [63-370ERV-01-SM](#)

L/XL product #: [63-370ERV-01-LX](#)

2XL/3XL product #: [63-370ERV-01-23](#)



SG JV

### 300RT/305RT VERSATILE WORKVEST



APPROVALS				
USCG TYPE				
III	IV	V	VI	VII



Useful for a multitude of diverse commercial applications

Two 1" body belts and one chest strap with heavy-duty type V buckles

Design protects shoulders while you carry items

SOLAS-grade reflective tape

300RT Adult Universal product # [65-300RT-001](#)

305RT Adult Magnum product # [65-305RT-001](#)



SG JV

### 310RT/315RT DELUXE WORKVEST



APPROVALS				
USCG TYPE				
III	IV	V	VI	VII



Useful for a multitude of diverse commercial applications

Two 1" body belts and one chest strap with heavy-duty type V buckles

Collar design protects workers' shoulders while carrying items

Four gusseted pockets reduce entanglement by hiding body belts

310RT Adult Universal product # [65-310RT-001](#)

315RT Adult Magnum product # [65-315RT-001](#)



## 280RT/285RT VINYL-DIPPED WORKVEST

SG  
JV



OPENING  
ON BACK  
PANEL

Smooth, durable vinyl coating over self-extinguishing contoured flotation foam panels

SOLAS-grade reflective tape

Adjustable chest and shoulder straps, and opening on back accommodates most fall protection harnesses

280RT product # 65-280RT-001

280RT (NAFTA compliant) product # 65-280RT-USA

285RT (Heavy-duty metal buckles) product # 65-285RT-001



## 290RT RIGGER I / 290EFRT RIGGER II

SG  
JV



Both vests feature lightweight construction for wearer comfort and two encircling belts with snag resistant buckles

Rigger I features soft cotton twill covering draws sweat away from worker

Rigger II features durable 200 Denier polyester covering resists UV deterioration

SOLAS-grade reflective tape

290RT Rigger I product # 65-290RT-001

290EFRT Rigger II product # 65-290EFRT-001





## HARD SHELL LIFE RING BUOYS



High impact linear low-density polyethylene with molded-in rope holes  
Easily replaceable 3/8" UV-resistant polypropylene rope

### Life Ring Buoy

30" Domestic Type (2.5 kg Orange)  
product # [10-R0300D-SSPI](#)

### Life Ring Buoy With Reflective Tape

30" Bridge Type (4.0 kg Orange)  
product # [10-R0340D-SSPI](#)

30" Deck Type (2.5 kg Orange) product # [10-R0325D-SSPI](#)

24" Ring Buoy Orange (USCG only)  
product # [10-R024RD-SSPI](#)

### Ring Buoy Line Bag

100ft of hollow braid polypropylene rope in nylon bag  
product # [69-RBLB](#)





**Crewsaver®**  
Safer By Design

**INFLATABLE  
PFDS**

**SG  
JV**

APPROVALS				
USCG TYPE				
I	II	III/V	IV	V

Light and flexible dual chamber lifejackets with high visibility inflation chambers

Each chamber is fitted with a 3.5psi relief valve to ensure full buoyancy during single or double chamber inflation

**150N Crewfit Twin 2010**

auto inflating with (2) 38g cylinders

hammar product # 61-1353-HAMM

hammar w/hood product # 61-1353-H+H

hammar w/harness product # 61-1354-HAMM

**275N Seacrewsader 2010**

auto inflating with (2) 60g cylinders

product # 61-1142-AUTO

w/harness product # 61-1142-AUTOH

w/heavy duty cover

product # 61-1142-HDAUTO

w/heavy duty cover & harness

product # 61-1142-HDAUTOH

w/fire retardant cover

product # 61-1142-FRAUTO

w/fire retardant cover & harness

product # 61-1142-FRAUTOH

**ADDITIONAL  
COMBINATIONS  
OF MECHANISM,  
COVER AND  
HARNES  
AVAILABLE  
UPON REQUEST  
FOR BOTH THE  
CREWFIT AND  
SEACREWSADER.**

**CONTACT YOUR  
SALES MANAGER  
FOR MORE  
INFORMATION.**



**CREWFIT TWIN  
WITH REGULAR COVER  
AND HARNES**



**HEAVY DUTY COVER  
FOR CREWFIT**



**FIRE RETARDANT  
COVER ON CREWFIT**





SG  
JV

## HYBRID LIFEJACKETS



**Crewsaver®**  
Safer By Design

Hybrid PFDs provide 50N of buoyancy by soft PVC foam panels, and additional buoyancy with the manually operated 150N chamber

Both models are designed for a tough working environment and feature SOLAS-grade reflective tape, heavy duty zipper, whistle, utility pocket on chest, twin layer outer cover for protection and elasticated mesh side panels allowing comfortable fit for most adults

Harvester Swift Water Rescue (SWR) also includes a break-away belt

150N Harvester 150N product # [67-8670-A](#)

150N Harvester SWR product # [67-8677-A](#)



SG  
JV

## ERGOFIT LIFEJACKETS



**Crewsaver®**  
Safer By Design

ErgoFit Ocean approved to ISO 12402-2 (275N) but exceeds approval with minimum buoyancy of 290N

ErgoFit Offshore and Coastal models approved to ISO 12402-3 (150N) but exceed approval with minimum buoyancy of 190N

All models feature an inflation chamber that ensures fast turn speed when entering the water, and keeps the airway clear of water

The ErgoFit Ocean and Offshore models feature innovative 3D shaping, providing a custom fit with one universal size, as well as a dynamic cutaway design allowing full freedom of movement

The 190N Coastal features quick fix rear buckles which adjust for exceptional fit and easy of movement, and easy donning with front zip

### 290N Ocean Automatic Inflation Models

w/Hammar mechanism product # [67-1300-HAMM](#)

w/standard mechanism product # [67-1300-AUTO](#)

### 190N Offshore Automatic Inflation Models

w/Hammar mechanism product # [67-1301-HAMM](#)

w/standard mechanism product # [67-1301-AUTO](#)

### 190N Coastal Automatic Inflation Models

w/Hammar mechanism, light and hood product # [61-1302-HAMMLH](#)

w/standard mechanism product # [67-1302-AUTO](#)

w/standard mechanism, light and hood product # [67-1302-AUTOLH](#)

### 190N Coastal Manual Inflation Model

product # [67-1302-MANL](#)



**Commercial Inflatable**  
45-61019-105BK  
45-61019-105SO

Automatic Inflation



Commercial Inflatable Rearming Kit  
part # 45-RAKA **SG JV**



**Crewsaver®**  
Safer By Design

**Crewfit**  
61-1353-HAMM  
61-1353-H+H  
61-1354-HAMM

Automatic Inflation



150N Crewfit Rearming Kit  
part # 61-10019 **SG JV**

**Seacrewsader**  
61-1142-AUTO  
61-1142-AUTOH  
61-1142-HDAUTO  
61-1142-HDAUTOH  
61-1142-FRAUTO  
61-1142-FRAUTOH

Automatic Inflation



275N Seacrewsader Rearming Kit  
part # 61-11037 **SG JV**

**Harvester**  
61-8670-A  
61-8677-A

Automatic Inflation



150N Harvester Rearming Kit  
part # 61-10019 **SG JV**

<b>Crewsaver®</b> Safer By Design						
<b>ErgoFit Ocean</b> 61-1300-HAMM	<b>ErgoFit Ocean</b> 61-1300-AUTO	<b>ErgoFit Offshore</b> 61-1301-HAMM	<b>ErgoFit Offshore</b> 61-1301-AUTO	<b>ErgoFit Coastal</b> 61-1302-HAMM 61-1302-HAMMLH	<b>ErgoFit Coastal</b> 61-1302-AUTO 61-1302-AUTOLH	<b>ErgoFit Coastal</b> 61-1302-MANL
Hammar Automatic Inflation	Standard Automatic Inflation	Hammar Automatic Inflation	Standard Automatic Inflation	Hammar Automatic Inflation	Standard Automatic Inflation	Manual Inflation
290N ErgoFit Rearming Kit part # 61-11307 <b>SG JV</b>	290N ErgoFit Rearming Kit part # 61-11037 <b>SG JV</b>	190N ErgoFit Rearming Kit part # 61-11306 <b>SG JV</b>	190N ErgoFit Rearming Kit part # 61-10007 <b>SG JV</b>	190N ErgoFit Rearming Kit part # 61-11306 <b>SG JV</b>	190N ErgoFit Rearming Kit part # 61-10007 <b>SG JV</b>	190N ErgoFit Rearming Kit part # 61-10034 <b>SG JV</b>

SG  
JV

## WATER-ACTIVATED LIFEJACKET LIGHT (CSL)



**Crewsaver®**  
Safer By Design



Min. 1.3cd output white flashing LED lifejacket light  
Optimum output levels exceeds 3cd

Powered by a Duracell  
Ultra 3v lithium-ion battery

CSL  
product # 10-10220

SAMPLE

SG  
JV

## LIFEJACKET LIGHTS



**DANIAMANT**



Both models are fully MED and IMO SOLAS approved and easily fitted with two different backing plates, for thin strap or 5cm belt mounting

Min. 0.75cd light output

M3 is manual version which can be activated by rotating the light dome and W3 version activates automatically when in water

Battery integrated into unit

5 year battery storage life

M3 product # 10-1130-M3

W3 product # 10-1330-W3

SAMPLE

SG  
JV

## LIFE BUOY LIGHTS



**DANIAMANT**



Only offering that includes all these standards and the ability to fit USCG approved Intrinsically Safe Light vessels classified under USCG requirements

Approved to USCG standard UL1196, SOLAS/MED and ATEX, IECEx and ETL listing under UL913

Both models pass drop height test of 76 meters

Intrinsically safe model (category 1) makes the L163 suitable in hazardous zones 0, 1 and 2

Min. 2cd light output with min. 15 hour light duration

L162  
product # 10-62-003A-L162

L163 Intrinsically Safe Model  
product # 10-62-003A-L163

SAMPLE

SG  
JV

## SLX SOLAS PFD LIGHT

*Electric Fuel*



Min. .75cd output white flashing LED light with operating life exceeding 8 hours

Approved to 1999 SOLAS amendments

Compact, lightweight and easy to secure with built-in attachment clip

Automatic activation in both salt and fresh water

SLX product # 10-SLX

THIS PAGE INTENTIONALLY LEFT BLANK

# RESCUE EQUIPMENT & MARINE ACCESSORIES

Personnel Recovery Device 701  
Rescue Ramp 702  
Dry Suits 703

Helmets and Rescue Rope 704  
Marine Accessories 705





**Crewsaver®**  
Safer By Design

# CREWSAVER PERSONNEL RECOVERY DEVICE (CPRD)

The Crewsaver Personnel Recovery Device (CPRD) is a man overboard retrieval device (MOB), ergonomically designed to assist in the retrieval of conscious and unconscious people from the water.

Retrieval of subjects can be made horizontally without risking further injury to the them or to the rescuer.



Construction from high density plastic rungs and stainless steel rods

Fitted with Marine Grade 316 stainless steel snap hooks

SOLAS approved and available in a variety of sizes

Lifting strops and heaving lines are attached to aid with retrieval

Each CPRD is tailored to suit the individual needs of the application

## FAST RESCUE CRAFT (FRC) VERSION

Available in two sizes as a complete kit: 3 x 14 or 4 x 15

Supplied in a robust, high-visibility valise

Compact enough to be stowed in the craft

Comes with "Hypalon" patch fixing kits to enable attachment to the inflatable tubes on the rescue craft

**N.B. MCA RECOMMEND A CPRD IS INSPECTED EVERY 3 YEARS BY AN APPROVED SERVICE STATION**

NUMBER OF RUNGS WIDE	NUMBER OF RUNGS LONG (RANGE OF AVAILABLE CONFIGURATIONS)	F/B (BASED ON CONFIGURATION)	DIMENSIONS WHEN DEPLOYED (BASED ON CONFIGURATION)	PRODUCT #	SG VN
4	12 - 37	0.5 - 3.6	26"x68" - 26"x210"	Call	
5	10 - 36	0.4 - 3.5	33"x57" - 33"x203"	Call	
6	12 - 28	0.5 - 2.5	40"x68" - 40"x158"	Call	
7	12 - 32	0.5 - 3.0	46"x68" - 46"x203"	Call	
8	12 - 36	0.5 - 3.5	53"x68" - 53"x203"	Call	
9	12 - 40	0.5 - 4.0	60"x68" - 60"x225"	Call	
10	12 - 44	0.5 - 4.0	66"x68" - 66"x248"	Call	
11	12 - 45	0.5 - 4.6	73"x68" - 73"x254"	Call	
12	12 - 45	0.5 - 4.6	79"x68" - 79"x254"	Call	

## FRC MODELS

NUMBER OF RUNGS WIDE	NUMBER OF RUNGS LONG	F/B	DIMENSIONS WHEN DEPLOYED	PRODUCT #	SG VN
3	14	0.8	20"x79"	SEPRD314FRC	
4	15	0.9	27"x85"	SEPRD315FRC	

# RESCUE RAMP MKI - MKII EPE



The rescue ramp is an easy to use, flexible and cost-effective recovery system contained within a compact, portable fabric valise. It is lightweight and easy to transfer from the protected storage location to any preset recovery point. A recovery point is an area that is less than one meter from the water and has attachment points set up for the rescue ramp snap shackles as per the installation section of this manual. Use of the ramp is simple: simply snap the shackles into place, open the velcro on the sides and pull the webbing handle to inflate the ramp.



Ideal deployment point should 39" (1 meter) or less

Minimum working load of 1,100 lbs (500kg)

Manufactured with two independent inflatable chambers, each with its own relief valve and manual filling valve

Fabric valise should be stored in an indoor location or water-tight locker

Includes two rescue quoits

One year service interval (or after deployment, whichever comes sooner)



Contact us to learn more about pricing and ordering

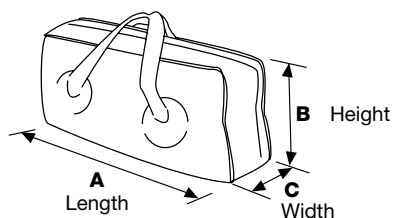

SPECS	A X B X C DIMENSIONS	NET WEIGHT	NOTES
EPE	36" x 16" x 16" (900x400x400mm)	42 Lbs. (19kg)	60" (1.5m) painter line length Inflation Cylinder 1 x 4 L
Crate	40" x 20" x 20" (1000x500x500mm)	89 Lbs. (40kg)	8.83 ft <sup>3</sup> enclosed



**RESCUE RAMP DEPLOYED**



**MKI FOLDED**

**MKII FOLDED IN VACUUM POUCH**

**FABRIC VALISE**



**Crewsaver®**  
Safer By Design

**CIRRUS  
DRYSUIT**



Fully breathable fabric with taped seams and front entry dry zip

Reinforced knees and abrasion resistant seat for durability

Latex Socks

Includes removeable fleece liner roll-top storage bag

Glideskin neoprene neck and cuff seals for comfort  
Internal adjustable suspenders provide additional comfort for wearer

**Sizes in Black/Red**

- product # 80-6515-S
- product # 80-6515-M
- product # 80-6515-L
- product # 80-6515-XL
- product # 80-6515-XXL

**Sizes in Black/Grey**

- product # 80-6516-S
- product # 80-6516-M
- product # 80-6516-L
- product # 80-6516-XL
- product # 80-6516-XXL



**Crewsaver®**  
Safer By Design

**RESCUE  
DRYSUIT**



300D Nylon construction with EPE foam

600D reinforced seat and knee area

Reflective "RESCUE" print on the back of suit

Neoprene wrist, neck seal and lined collar

Sleeve pocket

Fleece included

**Sizes in Black/Red**

- product # 80-6569-S
- product # 80-6569-M
- product # 80-6569-L
- product # 80-6569-XL
- product # 80-6569-XXL



**Crewsaver®**  
Safer By Design

**SABRE  
DRYSUIT**



Ideal for public safety officers working in the worst weather who need a hard wearing, hard working drysuit

Suit is made of extremely breathable fabric with taped seams

Front curved dry zip for extreme flexibility, storm collar for extra protection against the elements, and glideskin neoprene neck and cuff seals for comfort

Fitted with latex socks

**Sizes in Black**

- product # 80-6551-S
- product # 80-6551-M
- product # 80-6551-L
- product # 80-6551-XL
- product # 80-6551-XXL







SG  
JV

## KONTOUR HELMET



Stylish, lightweight helmet with super high impact ABS hard shell that is CE Approved for impact resistance

Fully adjustable webbing cradle and heat sealed comfortable foam inserts for optimum fit

High density black EPS

Small/Medium Size:  
56-58cm circumference

Medium/Large Size:  
59-61cm circumference

### Sizes in Metallic Red

product # 66-6252-S/M  
product # 66-6252-M/L

### Sizes in Blue Weave

product # 66-6253-S/M  
product # 66-6253-M/L

### Sizes in Black Matte

product # 66-6254-S/M  
product # 66-6254-M/L

### Sizes in Silk Blue

product # 66-6256-S/M  
product # 66-6256-M/L



SG  
JV

## TORKEL HELMET



**Crewsaver**<sup>®</sup>  
Safer By Design

High impact ABS moulded outer shell

Fits head sizes 52-58cm

Multi-adjustable inner cradle for height and head size to ensure a secure, snug fit

High density foam lining for impact protection

Tough polyethylene ear strengthening pieces

Adjustable chin strap

**Red** product # 66-6312-AD

**Royal Blue** product # 66-6311-AD



SG  
JV

## RESCUE ROPE BAG



Heavy duty nylon bag with top cinch opening and 1" snap clip

Tough, high visibility yellow/red floating MFP rope

Bag and 100' length rope product # 69-RR100

Bag and 70' length rope product # 69-RR70

Bag and 50' length rope product # 69-RR50

BRAND	PRODUCT DESCRIPTION • PRODUCT # • PRODUCT DETAILS <span style="float: right; border: 1px solid black; padding: 2px;">S G J V</span>	IMAGE
	<p><b>Wrist T-Cuffs</b> • 80-I-0214 (small), 80-I-0213 (medium), 80-I-0212 (large), 80-I-0211 (extra large) • Neoprene forearm covers designed to keep the arms of personnel warm when they are processing cold fish</p>	
	<p><b>Thermal Protective Aid</b> • 10-100-03 • Designed to keep you warm and protected against rain, wind and cold; SOLAS-compliant; USCG/EC approved; sized large enough to accommodate a person wearing a lifejacket; all seams are heat welded</p>	
	<p><b>Jackknife With Can Opener</b> • 50-802 • Handles are extremely tough delrin plastic; adjustable lanyard loop / security closure; 72" cotton lanyard; lining made of brass</p>	
	<p><b>Whistle</b> • WHISTLE-USCG (bulk pack) • Powerful, dual-tone audible signal device; flat design meeting USCG/SOLAS requirements; complete with 15-inch lanyard</p>	
	<p><b>Anti-Sea-sick Tablets</b> • 50-364 • Packaged in individual cellophane strip packs; 12 pills per strip pack; heat-sealed with instructions in plastic bag; each package individually dated as required by the U.S. Food and Drug Administration</p>	
	<p><b>Drinking Water</b> • 10-REV022W • Light, individual use pouches; air/light-tight for maximum freshness; up to 5 year storage life; 4.25 oz. / 125 mL purified water; labeled with important water conserving practices in five languages</p>	
	<p><b>Food Rations</b> • 40-AV2000 • Emergency food rations, heat sealed in a vapor- proof barrier flexible pouch; manufactured in accordance; with military specification MIL-B-131F; 5 year storage life; 2,000 KCAL pack (4 bars, 14 oz./396g)</p>	
	<p><b>Food Rations</b> • 10-REV022 • Emergency food rations, heat sealed in a vapor- proof barrier flexible pouch; manufactured in accordance; with military specification MIL-B-131F; 5 year storage life; 2,400 KCAL pack (6 bars, 16.7 oz./475g)</p>	
	<p><b>Food Rations</b> • 10-REV021 • Emergency food rations, heat sealed in a vapor- proof barrier flexible pouch; manufactured in accordance; with military specification MIL-B-131F; 5 year storage life; 3,600 KCAL pack</p>	
	<p><b>Fishing Kit</b> • 50-182 • Packed in vapor-proof barrier flexible pouch; hooks, lines, flies, spoons and spinners; fishing instructions necessary for survival; manufactured in accordance with military specification MIL-B-131F</p>	
	<p><b>Life Raft First Aid Kit</b> • 50-180 • Comes in a transparent zip pouch and contains: adhesive bandages, gauze compress, 4" gauze bandage, 4" bandage compress, ammonia inhalants, eye dressing packs, wire splint, aspirin tablets, 2" bandage compresses, triangular bandage, eye washes, tourniquet; pouch dimensions: 7" x 9" x 3"</p>	
	<p><b>Life Boat First Aid Kit</b> • 50-181 • Comes in a heavy-duty plastic container with a water-tight O-ring and contains: adhesive bandages, large gauze compress, 4" gauze bandage, 4" bandage compress, burn creams, 2" bandage compress, eye washes; container dimensions: 10.5" x 10.5" x 3.5"</p>	

# SURVIVAL SUITS

Immersion Suits

801 - 802

Ice Rescue Suit

803





# IMMERSION SUITS

These superior-quality immersion suits have been in production since 1969... and in fact are the very first immersion suits to ever be seen on the maritime market. They are the world's best selling immersion suit and each is meticulously crafted and pressure-tested upon

completion. Survitec Group offers worldwide service stations for Imperial Immersion Suits for pressure-testing and inspections. Visit our website to find the station nearest to you.

EC Suit is required to be worn with a SOLAS approved lifejacket

Canadian Suit includes a buddyline and high-rider ring

SOLAS-grade reflective tape

USCG/SOLAS Suit includes lifting harness



Face Shield



**APPROVALS**

**JUMBO SIZE SHOWN**

**APPROVALS**

**ADULT SIZE SHOWN**

**APPROVALS**

**CHILD SIZE SHOWN**

**APPROVALS**

**ADULT SIZE SHOWN**

**KEY BENEFITS FOR ALL IMPERIAL IMMERSION SUITS:**

- 1-piece, sealed construction made of inherently buoyant 5mm neoprene
- True to size with dual-zipper pull tabs and wide shoulders and legs for quick donning
- Three-fingered mitt for increased hand warmth and palm grip studs for improved grasping

- Equipped with whistle
- Snug-fitting face seal helps keep water out and SOLAS reflective tape provides extra visibility of wearer to rescue team
- Entire suit weighs only 14 lbs

**ADDITIONAL FEATURES FOR USCG/SOLAS APPROVED VERSION:**

















- Inflatable high-rider ring for additional freeboard and buoyancy
- Lifting harness and buddy line

**OPTIONS:**

- Custom suits available upon request
- Personal survival kit pocket and PFD lights
- Custom stenciling with organization name

## 5 EASY STEPS TO DONNING



APPROVAL TYPE	SUIT SIZE / CASE QTY	SHIP'S REGISTRY	PRODUCT #	SG JV	HEIGHT RANGE	WEIGHT RANGE	APPROVAL #
USCG	Adult 	 USA	80-1409-A		4'11" - 6'3" (1.5m - 1.9m)	110 - 330 Lbs. (50 - 150kg)	161.171/208/0
	Intermediate 		80-1409-O		4-11" - 5'10" (1.5m - 1.8m)	110 - 180 Lbs. (50 - 80kg)	160.171/210/0
	Jumbo 		80-1409-J		Over 6'3" (Over 1.9m)	Over 220 Lbs. (Over 100kg)	161.171/209/0
	Child 		80-1409-C		3'3" - 4'2" (1m - 1.8m)	44-110 Lbs. (20-50kg)	160.171/4/0
USCG / SOLAS	Adult 	 USA	80-1409-A-3		4'11" - 6'3" (1.5m - 1.9m)	110 - 330 Lbs. (50 - 150kg)	161.171/208/0
	Intermediate 		80-1409-O-3		4-11" - 5'10" (1.5m - 1.8m)	110 - 180 Lbs. (50 - 80kg)	160.171/210/0
	Jumbo 		80-1409-J-3		Over 6'3" (Over 1.9m)	Over 220 Lbs. (Over 100kg)	161.171/209/0
TC / SOLAS	Adult 	 CAN	80-1409-NCA		4'11" - 6'3" (1.5m - 1.9m)	110 - 330 Lbs. (50 - 150kg)	T.C.315.070.001
	Intermediate 		80-1409-NCO		4-11" - 5'10" (1.5m - 1.8m)	110 - 180 Lbs. (50 - 80kg)	
	Jumbo 		80-1409-NCJ		Over 6'3" (Over 1.9m)	Over 220 Lbs. (Over 100kg)	
MED / SOLAS	Adult 	 EC	80-1409-ECA		4'11" - 6'3" (1.5m - 1.9m)	110 - 330 Lbs. (50 - 150kg)	ABS Notified Body 0729 certificate # 08-HS359384- 2-EC
	Intermediate 		80-1409-ECO		4-11" - 5'10" (1.5m - 1.8m)	110 - 180 Lbs. (50 - 80kg)	
	Jumbo 		80-1409-ECJ		Over 6'3" (Over 1.9m)	Over 220 Lbs. (Over 100kg)	

IMPERIAL IMMERSION SUITS COME COMPLETE WITH A COLOR-CODED, GENEROUSLY-SIZED BAG WITH TWO HANDLES

BAG	SIZE	SHIP'S REGISTRY	PART #	SG JV
	Adult	USA	80-I-0201	
		CAN	80-I-0201-NCA	
		EC	80-I-0201-ECA	
	Intermediate	USA	80-I-0200	
		CAN	80-I-0200-NCO	
		EC	80-I-0200-ECO	
	Jumbo	USA	80-I-0204	
		CAN	80-I-0204-NCJ	
		EC	80-I-0204-ECJ	
	Child	USA	80-I-0202	

IMMERSION SUIT ACCESSORIES AND MAINTENANCE	PART #	SG JV
Optional Personal Survival Pocket	80-1420	
Optional PLB Pocket	80-1421	
Maintenance Kit	80-1501-101	
Bees Wax Bar	80-I-1000	
USCG Replacement High Rider Ring	Adult Suit	80-1410-A
	Intermediate Suit	80-1410-O
	Jumbo Suit	80-1410-J
	Child Suit	80-1410-C
TC Replacement High Rider Ring	Adult Suit	80-1410-NCA
	Intermediate Suit	80-1410-NCO
	Jumbo Suit	80-1410-NCJ



# IR1500 ICE RESCUE SUIT

As today's most innovative marine public safety brand, Imperial proudly presents the Ice Rescuer 1500. Based on your input and the need for a robust, user-repairable, easy-to-don, and affordable ice rescue suit, the Ice Rescuer 1500 has all the features you need to get the job done.

Made of easy to repair, breathable shell fabric with cordura reinforced wear areas

Drysuit mobility, look and feel

Replaceable inner foam liner

Internal suspenders, wrist, thigh and ankle adjustments for more comfort

SOLAS-grade reflective tape on arms, head and torso

3-ply chemical resistant insulated gloves

Suit comes with a storage bag and repair kit

Additional features include attached booties, purge valve, AWL pockets, pull harness, and heavy-duty waterproof zipper

Suit Size: Adult Universal  
User Weight: 110 - 330 lbs  
User Height: 4'11" - 6'6"

IR1500 product # **SG JV**  
80-1500-UNIV

**Replacement items:**

Liner part # 80-1500-LINER

Harness part # 80-1500-HARNASS

Bag part # 80-1500-BAG

Tear Repair Kit part # 80-1500-RKIT



# ELECTRONICS

Choosing The Right One 901 - 902

EPIRBs 903 - 904

PLBs 905

Personal AIS Beacons 906

SARTs 907



GMDSS Radio 908





Hydrostatic Release Unit 908



# CHOOSING THE RIGHT ONE: TECHNOLOGY

The commercial marine market is very broad and includes electronics, safety and beacon products. Survitec Group is pleased to provide the most innovative safety beacons available in the world.



SIGNAL TYPE	SIGNAL DESCRIPTION	DEMONSTRATIVE IMAGE
406 MHZ	All EPIRBs transmit the 406 MHz distress signal. The 406 MHz alert signal can be detected by SAR satellites. American, European and Indian authorities operate a series of satellites in low-earth and geostationary orbits to detect and locate aviators, mariners and land-based users in distress. The satellites, together with a world-wide network of ground stations and Mission Control Centers (MCC) form the International COSPAS-SARSAT Program whose mission is to relay distress signals to the international search and rescue community.	
121.5 MHZ	All EPIRBs transmit the 121.5 MHz homing signal which is standard on all RTCM approved beacons along with 406 MHz.	
GPS	Many beacons have built-in GPS transmitters as an optional feature, which improve speed and accuracy of rescue. Beacons employing this technology are capable of providing typical positional accuracy of +/- 200ft and updates every 20 minutes.	
AIS	<p>Automatic Identification System-enabled beacons, including SART and Personal AIS Beacons, transmit signals that can be picked up on any existing chart plotter that has integrated AIS (most modern navionics electronics do). If a member of the crew goes overboard, when they activate their AIS beacon, the signal shows up on their ship's AIS-enabled chart plotter, and the other crew can quickly locate and rescue the member in danger.</p> <p>Contrast this with the 406 MHz system, where a rescue signal is 1. relayed to satellites, 2. relayed to a search and rescue deployment center, 3. then sent to whoever is closest, 4. then they begin to look. AIS technology expedites the alert by sending an AIS signal to all vessels within 4 nautical miles (depending on sea conditions), which of course most likely includes the crewmember's own ship. This increases the speed to rescue.</p>	

BEACON TYPE	MOUNT	PURPOSE	EXAMPLE
Emergency Position-Indicating Radio Beacon (EPIRB)	Installed to vessel bulkhead	Intended to deploy in the event of ship distress and alert the nearest rescue authorities. <b>For Ship.</b>	McMurdo SmartFind EPIRB 
Personal Locator Beacon (PLB)	Fastened to or carried by vessel personnel	Intended to be activated in the event of personnel distress, such as separation from or sinking of ship, and alert the nearest rescue authorities. <b>For You.</b>	McMurdo Fast Find 220 PLB 
Personal AIS Beacon	Fastened to or carried by vessel personnel	Intended to be activated in a man-overboard situation to alert all vessels in vicinity of need for rescue. <b>For Crew.</b>	McMurdo SmartFind S20 Personal AIS Beacon 
Search And Rescue Transmitter (SART)	Packed in escape craft, such as a liferaft	Intended to be activated after personnel have escaped ship sinking in rescue craft, to alert the nearest rescue authorities and all vessels in vicinity. <b>For Liferafts and Lifeboats.</b>	McMurdo SmartFind S5 AIS SART 



# CHOOSING THE RIGHT ONE: BRAND

BRAND	DESCRIPTION
McMurdo	Leading the way in maritime safety innovation for over 60 years, McMurdo is the #1 best-selling beacon in the world. Leveraging a strong foundation in industrial and commercial marine, McMurdo beacons are the professional's choice in the U.S., Canada and Latin America.
Kannad Marine	Kannad Marine has roots in the air safety industry, and along with a strong French design heritage, these beacons are a favorite of international leisure and recreational yacht vessels. Available to distributors for sale in Canada and Latin America.

FEATURE AND INNOVATION COMPARISON	 McMurdo Fast Find 220 PLB	 Other Brand X PLB
Battery Life	6 Years + to end user	Six (6) years from date of manufacture or five (5) years after beacon is placed into service, whichever is first. That means 5 years.
Bouyancy	Supplied standard with a flotation pouch.	Not supplied with a flotation pouch and is not buoyant. An end user must buy a different model, which is much larger and more expensive if you want your unit to float.
Antenna Housing	Completely hidden, with an opaque lid lacking any sharp edges.	Antenna is external, with sharp edges and a small plastic retaining clip.
Antenna Hinge	No antenna hinge. Antenna remains safely enclosed in housing during tests.	Antenna is hinged, and must be raised every battery test.
Label	Firmly adhered to back of product.	Hinged and flapping loose. If it breaks off, the activation instructions are lost.
Activation Buttons	ON and TEST buttons clearly separated.	ON and TEST buttons potentially confusing. Instructions for use are on tear-off section of label.
Altitude Rating	40,000 feet	No rating
SOS Flash Light	Yes	No
Subscription	Free - no fee whatsoever	406Link.com* Subscription fee required for optional non-distress messaging
Warranty	5 Years	5 Years
GPS Self Test	Yes	Yes
Flotation Pouch Included	Yes	No
Lanyard Included	Full-size neck lanyard	Wrist-only lanyard
Street Price	\$249.99	\$279.99
Annual Cost Of Ownership Until Battery Change	\$41.66	\$55.99

### THE BOTTOM LINE:

AFTER COMPARING MCMURDO BEACONS TO THEIR NEAREST COMPETITOR, IT IS IMMEDIATELY APPARENT THAT THE WEALTH OF FEATURES, THOUGHTFUL ENGINEERING, SUPERIOR TECHNOLOGY AND LOWER PRICE CLEARLY SHOW WHY MCMURDO IS THE #1 BEST SELLING BEACON IN THE WORLD.

**mcmurdo**  
safety for professionals

**SMARTFIND + G5  
GPS EPIRB**

SG  
JV

SAMPLE

FCC and internationally approved

Transmits on 406 and 121.5 MHz

High brightness LED flashing locator light and integrated GPS

Once activated, will transmit for a min. of 48 hours

Non-hazardous battery for safe and easy transportation

5 year warranty and 6 year battery storage life

60 comprehensive diagnostic and self-tests during battery life

Unique CARRYSAFE bracket available for safe transportation

2 options for mounting EPIRB:  
Automatic Cat I Housing or  
Manual Cat II Bulkhead Bracket

Auto Cat I product # **82-800-002A**

Manual Cat II product # **82-800-001A**



**mcmurdo**  
safety for professionals

**SMARTFIND E5  
406MHZ EPIRB**

SG  
JV

FCC and internationally approved

Transmits on 406 and 121.5 MHz

High brightness LED flashing locator light

Once activated, will transmit for a min. of 48 hours

Non-hazardous battery for safe and easy transportation

5 year warranty and 6 year battery storage life

60 comprehensive diagnostic and self-tests during battery life

Unique CARRYSAFE bracket available for safe transportation

2 options for mounting EPIRB:  
Automatic Cat I Housing or  
Manual Cat II Bulkhead Bracket

Auto Cat I product # **82-800-004A**

Manual Cat II product # **82-800-003A**





ONLY AVAILABLE  
FOR SALE IN CANADA,  
CENTRAL AND SOUTH  
AMERICA

SAMPLE

SG  
JV

## SAFELINK SPORTPRO + GPS EPIRB

kannad  
marine

FCC and internationally approved

Transmits on 406 and 121.5 MHz

High brightness LED flashing  
locator light

Once activated, will transmit for a  
min. of 48 hours

Non-hazardous battery for safe  
and easy transportation

5 year warranty and 6 year battery  
storage life

60 comprehensive diagnostic and self-tests  
during battery life

Unique CARRYSAFE bracket available for  
safe transportation

2 options for mounting EPIRB: Automatic Cat  
I Housing or Manual Cat II Bulkhead Bracket

Auto Cat I product # [10-K82-813-002A](#)

Manual Cat II product # [10-K82-813-001A](#)



ONLY AVAILABLE  
FOR SALE IN CANADA,  
CENTRAL AND SOUTH  
AMERICA

SG  
JV

## SAFELINK SPORTPRO 406MHZ EPIRB

kannad  
marine

FCC and internationally approved

Transmits on 406 and 121.5 MHz

High brightness LED flashing  
locator light

Once activated, will transmit for a  
min. of 48 hours

Non-hazardous battery for safe  
and easy transportation

5 year warranty and 6 year battery  
storage life

60 comprehensive diagnostic and self-tests  
during battery life

Unique CARRYSAFE bracket available for  
safe transportation

2 options for mounting EPIRB: Automatic Cat  
I Housing or Manual Cat II Bulkhead Bracket

Auto Cat I product # [10-K82-814-002A](#)

Manual Cat II product # [10-K82-814-001A](#)



**mcmurdo**  
safety for professionals

**FAST FIND  
220 PLB**



Light, compact and durable 406MHz PLB with 50-channel integral GPS and three stage activation for min. 24 hours continuous operation  
FCC and internationally approved

Waterproof to 30 feet and operates at temperatures down to -20°C  
Buoyant if used with included flotation pouch

Additional features: also includes lanyard and universal pouch, SOS LED flash light, unit is subscription-free with no call charges, 6 year battery storage life  
220 product # **10-91-001-220A**



**mcmurdo**  
safety for professionals

**FAST FIND  
MAX-G PLB**



406MHz PLB with 50-channel integral GPS and three stage activation for min. 48 hours continuous operation  
FCC and internationally approved  
User-replacable battery

Waterproof to 30 feet and operates at temperatures down to -20°C  
Inherently buoyant

Additional features: includes lanyard and universal pouch, SOS LED flash light, unit is subscription-free with no call charges, 6 year battery storage life  
Max-G product # **10-85-890-001A**



**kannad**  
marine

**SAFELINK  
PRO PLB**



406MHz PLB with 50-channel integral GPS and three stage activation for min. 48 hours continuous operation  
FCC and internationally approved  
User-replacable battery

Waterproof to 30 feet and operates at temperatures down to -20°C  
Inherently buoyant

Additional features: includes lanyard and universal pouch, SOS LED flash light, unit is subscription-free with no call charges, 6 year battery storage life  
Pro product # **10-K85-890-004A**

**ONLY AVAILABLE  
FOR SALE IN CANADA,  
CENTRAL AND SOUTH  
AMERICA**





## SMARTFIND S20 PERSONAL AIS

**mcmurdo**  
safety for professionals

Provides accurate GPS target tracking position information with serialized ID to plotters and onboard navigation systems to assist fast recovery in a man overboard situation

Small and lightweight for mounting on lifejacket

Semi-automatic activation possible when installed on lifejacket by approved service station

AIS channel 1 -161.975MHz, AIS channel 2 - 162.025MHz

Message 1 (TXID, GPS position, SOG, COG, UTC),  
Message 14 (MOB-ACTIVE or MOB-TEST)

4 nautical mile transmit range based on sea conditions

Min. 24 hour continuous operation

Additional Features: Integrated GPS, LED flashing indicator, audible buzzer, 7 year battery life

S20 product # **10-98-001-002A**



## SMARTFIND S10 PERSONAL AIS

**mcmurdo**  
safety for professionals

Provides accurate GPS target tracking position information with serialized ID to plotters and onboard navigation systems to assist fast recovery of persons in difficulty

Small and light for unobtrusive carriage

Waterproof, buoyant and fully submersible to 180 feet

AIS channel 1 -161.975MHz, AIS channel 2 - 162.025MHz

Message 1 (UID, GPS position, SOG, COG, UTC), Message 14 (SART-ACTIVE or SART-TEST)

4 nautical mile transmit range based on sea conditions

Min. 24 hour continuous operation

Additional Features: Integrated GPS, LED flashing indicator, audible buzzer, 5 year battery life

S10 product # **10-98-051-001A**

ONLY AVAILABLE  
FOR SALE IN  
CENTRAL AND  
SOUTH AMERICA



## SAFELINK R10 PERSONAL AIS

**kannad**  
marine

Provides accurate GPS target tracking position information with serialized ID to plotters and onboard navigation systems to assist fast recovery in a man overboard situation

Small and lightweight for mounting on lifejacket

Semi-automatic activation possible when installed on lifejacket by approved service station

AIS channel 1 -161.975MHz, AIS channel 2 - 162.025MHz

Message 1 (TXID, GPS position, SOG, COG, UTC),  
Message 14 (MOB-ACTIVE or MOB-TEST)

4 nautical mile transmit range based on sea conditions

Min. 24 hour continuous operation

Additional Features: Integrated GPS, LED flashing indicator, audible buzzer, 7 year battery life

R10 product # **10-K98-001-001A**

**mcmurdo**  
safety for professionals

**S4 RESCUE  
SART**



FCC and internationally approved for ship or survival craft

Compact and lightweight with internal and external mounting options

Additional Features: Buoyant and waterproof to 30 feet, min. 96 hour operational battery life, audio/visual indication of operation with built-in test facility, 5 year battery storage life

S4 product # **10-86-300-001A**



**mcmurdo**  
safety for professionals

**SMARTFIND S5  
AIS SART**



FCC and internationally approved for ship or survival craft and comes complete in its own carry case

AIS channel 1 -161.975MHz,  
AIS channel 2 - 162.025MHz

Message 1, (TXID, GPS position, SOG, COG, UTC),  
Message 14, (SART-ACTIVE or SART-TEST)

Additional Features: Buoyant and waterproof to 30 feet, min. 96 hour operational battery life, visual indication of operation with built-in test facility, 5 year battery storage life

S5 product # **10-92-001-001A**



**kannad**  
marine

**RESCUER 2  
SART**



FCC and internationally approved for ship or survival craft

Compact and lightweight with internal and external mounting options

Additional Features: Buoyant and waterproof to 30 feet, min. 96 hour operational battery life, audio/visual indication of operation with built-in test facility, 5 year battery storage life

Rescuer 2 product # **10-K86-300-002A**

ONLY AVAILABLE  
FOR SALE IN CANADA,  
CENTRAL AND SOUTH  
AMERICA



**kannad**  
marine

**SAFELINK  
AIS SART**



FCC and internationally approved for ship or survival craft and comes complete in its own carry case

AIS channel 1 -161.975MHz,  
AIS channel 2 - 162.025MHz

Message 1, (TXID, GPS position, SOG, COG, UTC),  
Message 14, (SART-ACTIVE or SART-TEST)

Additional Features: Buoyant and waterproof to 30 feet, min. 96 hour operational battery life, visual indication of operation with built-in test facility, 5 year battery storage life

SafeLink product # **10-K92-001-002A**

ONLY AVAILABLE  
FOR SALE IN CANADA,  
CENTRAL AND SOUTH  
AMERICA



SG  
JV

## R5 GMDSS VHF HANDHELD RADIO

**mcmurdo**  
safety for professionals

FCC approved and  
MED (Wheelmark)

23 GMDSS channels  
with test report

Waterproof to 1/2  
meter for 1/2 hour

Dimming and  
backlight control

Battery indicator and  
battery-saving function

Dual / Tri watch

Lithium battery - primary

Belt clip and lanyard

Antenna whip

Storage base

Pack A includes all features of Pack B plus Li-  
ion rechargeable battery, single charger base,  
AC/DC converter adapter, and DC connector  
cables

R5 GMDSS Pack A product # [10-20-001-01A](#)

R5 GMDSS Pack B product # [10-20-001-02A](#)

SAMPLE

SG  
JV

## BREAKTHRU HYDROSTATIC RELEASE UNIT

**mcmurdo**  
safety for professionals



Automatically released if vessel sinks

Incorporates a specially designed plastic bolt which secures  
the EPIRB to the casing and the bolt is cut on activation

The bolt should be replaced every 2 years when the HRU is  
replaced

BreakTHRU product # [10-82-962-001A](#)



THIS PAGE INTENTIONALLY LEFT BLANK



# TRAINING & MARKETING MATERIALS

Marketing Support & Fulfillment 1001  
Customer Advertising Allowance Plan 1002  
Exhibition Sponsorship 1003  
Product Dummies & Samples 1004 - 1005

Literature 1006  
Signage 1007  
Other Materials 1008



# MARKETING SUPPORT & FULFILLMENT

Survitec Group stands by its distribution partners throughout North America, offering programs and pricing to customers so that they can compete and win in their markets. We also provide tools for supporting the sale of those items to your end users through marketing and training communication materials.

## Ordering Non-sellable Items

Dummy products, signs, literature and other tangible materials are ordered the same way you send in your purchase orders to Account Services. Most items are available in limited quantities, provided free of charge. Simply complete the order form (shown below left) and email to [jacksonville.sales@survitecgroup.com](mailto:jacksonville.sales@survitecgroup.com) or fax to 904-562-5901.

The form may be downloaded from <http://www.survitecgroup.com/uploads/files/SDFOR01A.pdf>

## Ordering Design Services

There are times a customer needs artwork or visual communications items that are not covered under our existing tangible inventory. Non-tangible content such as artwork for print collateral, advertisements, signage, website banner advertisements and email blasts may be ordered from the Survitec Group Marketing Department. The first step is to email a Marketing Production Request (shown below right) to [marketing-sspi@survitecgroup.com](mailto:marketing-sspi@survitecgroup.com) which provides documentation of the general details for the project. Our Marketing Manager will contact you to arrange a meeting over the phone and discuss additional content or information needed, as well as any costs involved in final production (if desired).

The form may be downloaded from <http://www.survitecgroup.com/uploads/files/SDFMPP1A.pdf>

**survitecgroup** **ORDER FORM**  
 If you need additional information, please contact our Account Service Department by phone at (904) 562-5901, fax to (904) 562-5901 or email to [jacksonville.sales@survitecgroup.com](mailto:jacksonville.sales@survitecgroup.com)

TODAY'S DATE: \_\_\_\_\_ TIME:  a.m.  p.m. PURCHASE ORDER: \_\_\_\_\_

REQUESTED BY: \_\_\_\_\_

EMAIL: \_\_\_\_\_ PHONE: \_\_\_\_\_ FAX: \_\_\_\_\_

BILL TO: \_\_\_\_\_ SHIP TO: \_\_\_\_\_

ADDRESS: \_\_\_\_\_ ADDRESS: \_\_\_\_\_

CITY: \_\_\_\_\_ CITY: \_\_\_\_\_

STATE/PROVINCE: \_\_\_\_\_ STATE/PROVINCE: \_\_\_\_\_

ZIP/POSTAL CODE: \_\_\_\_\_ ZIP/POSTAL CODE: \_\_\_\_\_

COUNTRY: \_\_\_\_\_ COUNTRY: \_\_\_\_\_

METHOD OF PAYMENT:  Wire Transfer  Other  Credit Card  Net 30

Commercial Address  Residential Address

\* DATE NEEDED IN-HANDS: \_\_\_\_\_ SHIPPING INSTRUCTIONS: \_\_\_\_\_

\* In-hands date must be calculated to include:  
 1. Please note orders normally require 2 full business days (48 hours) to ship items in stock.  
 2. If shipping (Overseas), calculated delivery days from 30228 range from 1-8 business days.

LINE	PART NUMBER	DESCRIPTION	QTY	PRICE/NOTES
1				
2				
3				
4				
5				
6				
7				
8				
9				
10				

SPECIAL NOTES: \_\_\_\_\_

IF MORE THAN 10 LINE ITEMS ARE NEEDED, PLEASE CONTINUE ONTO PAGE 2

FOR OFFICE USE ONLY

DATE CONFIRMED: \_\_\_\_\_ VIA: \_\_\_\_\_

DATE ORDERED: \_\_\_\_\_ SALES ORDER: \_\_\_\_\_

DATE SHIPPED: \_\_\_\_\_ VIA: \_\_\_\_\_

OTHER NOTES: \_\_\_\_\_



**survitecgroup** **MARKETING PROJECT PRODUCTION**  
 If you need additional information, please contact Jonathan Finde, Marketing Manager - North America by phone at (904) 562-5900 ext. 340 or email to [jofin@survitecgroup.com](mailto:jofin@survitecgroup.com)

CATEGORY:  Revise Existing Content  Create New Content  Other

ASSOCIATION:  Survitec Colleague  Sales Representative  Survitec Customer  Survitec Vendor

REQUESTOR: \_\_\_\_\_ TITLE: \_\_\_\_\_

COMPANY: \_\_\_\_\_

EMAIL ADDRESS: \_\_\_\_\_

PHONE NUMBER: \_\_\_\_\_ TODAY'S DATE: \_\_\_\_\_ \*DATE NEEDED IN-HANDS: \_\_\_\_\_

\* In-hands date considerations:  
 1. Development time for all projects vary, based on the complexity of the project and the medium. For example, using an old print advertisement, revising and reproofing for a new placement can be completed and a final draft, put in-hands within 2 days. Creating the same advertisement from scratch, using new stock photography or text, and a new layout takes longer.  
 2. Deadlines should be established to include at least two rounds of revisions, or drafts. As a good rule of thumb, plan on total projects taking 1 week to get to draft 1, then 2 more days to draft 2, and 2 more days after that for draft 3. That makes a total of 3 business days. Again, exact timelines are based on medium, time and complexity of work.  
 3. If the item is a print collateral piece that must be produced, that adds another 3-5 business days for printing after the final proof is approved. Then there is shipping, with delivery times varying from 1-6 days, based on your distance from 30228.  
 As a general rule, allow for an average of 2 weeks for new marketing materials to be produced from the date of request. Requests are processed in the order received and urgent work scheduled in with existing obligations.

PRIORITY: \_\_\_\_\_

ROI GOAL: \_\_\_\_\_

PROJECT NAME: \_\_\_\_\_

DESCRIPTION: \_\_\_\_\_

PROBLEM TO BE SOLVED: \_\_\_\_\_

TARGET AUDIENCE / DEMOGRAPHIC: \_\_\_\_\_

CALL-TO-ACTION / DESIRED OUTCOME: \_\_\_\_\_

OVERALL PERSONALITY / FEELING OF CREATIVE: \_\_\_\_\_

MEDIUM(S) APPLICABLE:	TECHNICAL SPECIFICATIONS/DESCRIPTION:	OTHER NOTES:
<input type="checkbox"/> Apparel (see Dress, Shirt, Hat)		
<input type="checkbox"/> Collateral (see Print or Flex Collateral)		
<input type="checkbox"/> Display (see PowerWall, Announcements)		
<input type="checkbox"/> Document (see Print, List, News)		
<input type="checkbox"/> Interactive (see Online Ad Website)		
<input type="checkbox"/> Promotional (see Print, Sign)		
<input type="checkbox"/> Public Relations (see Press Release)		
<input type="checkbox"/> Signage (see Poster, POP, Material)		
<input type="checkbox"/> Trade Show (see Booth, Logistics)		
<input type="checkbox"/> Other:		

ADDITIONAL NOTES: \_\_\_\_\_



# CUSTOMER ADVERTISING ALLOWANCE PLAN

The Survitec Group Customer Advertising Allowance Plan, or CAAP, was developed in 2012 to drive localized advertising by customers. This program only applies to purchases made from Survitec Group in Jacksonville. Participation and the amount of allowance is managed by each Sales Manager. They review a customer's invoiced sales from Jacksonville for the current calendar year, and may approve a credit memo amount of up to 2%. The amount awarded is based on availability of funds and priority of placements, determined by the Sales Manager. This is how it works for each customer:

1. You propose a local advertising opportunity to your Survitec Group Sales Manager, featuring the brands and products that you sell and we supply from Jacksonville. Details are available on the plan description document shown below left.

The document may be downloaded from <http://www.survittegroup.com/uploads/files/SDCAAP1A.pdf>

2. The Survitec Group Sales Manager approves the placement/cost and the Survitec Group Marketing Manager approves the design. Print and online design services are available from Survitec Group for your placement, free of charge.

3. You place the approved advertising in the publication/media agreed upon.

4. At the end of the calendar year, you submit all approved CAAP placement samples with the invoice and proof of costs for those placements. Also include a completed credit memo form (shown below right) on which the amount matches the agreed upon amount.

The form may be downloaded from <http://www.survittegroup.com/uploads/files/SDFCUC1A.pdf>



### CUSTOMER ADVERTISING ALLOWANCE PLAN

Survitec Group (SG) does not offer a sales percentage based co-op rebate plan. Instead, we offer a Customer Advertising Allowance Plan (CAAP) to help defray expenses related to producing and placing eligible local advertising for the products covered by this plan.

<b>Eligible Products:</b>	Survitec Group, Survitec Survival Products, New Wave, Imperial, Cressman, Fuel First, McMurdy, Karmel Marine, Paris Wessac, Electric Fuel and Damasco commercial marine products are eligible for advertising allowances under the SG CAAP.
<b>Important Dates:</b>	Effective on advertising completed between January 1, 2013 through December 31, 2013. Funds accrue based on NET SALESMENTS made between January 1, 2013 and December 31, 2013. Claims must be submitted before 5:00pm EST on January 31, 2014.
<b>Program:</b>	SG CAAP will be accrued based upon net shipments to customers at an accrual rate of 3 percent. Any product invoiced before the published SG Distributor Price List does not qualify for advertising allowance. If you are unsure if your price qualifies, contact your Sales Manager for verification. CAAP is limited to a maximum of \$5,000.00 per customer per annum. Not eligible items include all shipments, including: • Freight Charges • Discontinued Items • Returns • Miscellaneous Charges other than Merchandise
<b>Important Note:</b>	SG pays 100% of the eligible advertising program costs, up to the accrued amount. This is not a co-op plan. SG will pay for only the portion of the advertisement that features SG products, logo, and trademark. For an advertisement to qualify for complete expense reimbursement, it must exclusively promote SG products and no other products. If you are unsure if your advertisement or placement qualifies, contact your Sales Manager for verification.
<b>Who Qualifies:</b>	Authorized SG customers.
<b>Eligible Media:</b>	The following will be eligible for local advertising support: • Newspaper Advertisements • Store Tabloid - same as newspaper inserts • Newspaper Inserts - cost of printing and insertion • Envelope Enclosure • Catalog or Catalog Inserts - same as newspaper inserts • Distributor Catalogs Trade show participation does not qualify unless approved in writing by SG Jacksonville Office. Any form of the above media used by a customer must feature the SG brand name of the eligible products listed above to be acceptable. Any customer wishing to use an alternate media or advertising format/method should submit a written request to SG for advance approval. No reasonable, comparable form of advertising will be arbitrarily excluded.
<b>How to Claim Credit:</b>	All claims must include three elements: 1. Copy of written approval for advertisement eligibility 2. Proof of Performance - One complete copy of tear-sheet, with identifying date and name of paper on each page, complete copy of catalog showing catalog page, or relevant demonstration of the advertisement. 3. Proof of Expense - Invoice indicating net cost of space, time, etc.
<b>Claims Process:</b>	Claims will be processed in the first week of the month following the month in which they are received. Assuming all the paperwork has been properly prepared and enough funds exist in the customer's accrual account to cover the amount of the claim, this amount should be credited to the customer's account by the end of the following month. No cash or check claims will be provided - customer credit only. Any questions regarding the accuracy or validity of the claim will be handled before the credit is made. Customers cannot deduct the amount of their claim from merchandise invoices.
<b>Overage Procedure:</b>	Advertising funds accrued in the calendar year and not used by February 28, 2013 will be withdrawn. NO EXCEPTIONS.
<b>Conclusion:</b>	SG reserves the right to terminate or amend this plan at any time, providing 60 days notice is given to the customer. Any funds rightfully due to a SG customer at that time should continue to be available to time previously outlined in this plan. To the best of our knowledge and belief, this plan conforms to the regulations of the Federal Trade Commission.
<b>Claims and Questions:</b>	Address all claims, questions, and correspondence to: SURVITEC GROUP ATTN: ACCOUNT SERVICES 1910 CABOT COMMERCE CIRCLE, BUILDING 1, SUITE 100 JACKSONVILLE, FLORIDA 32206 USA





**Survitec Group**  
 Survitec Survival Products, Inc.  
 11679 Cabot Commerce Circle, Building 1, Suite 100, Jacksonville, FL 32206 USA  
 Tel: +1 904 952 3300 / Fax: +1 904 952 3341 / Email: jacksonville@smg-survittegroup.com  
 www.survittegroup.com

### CUSTOMER CREDIT REQUEST

Please complete fully to request a credit from Survitec Survival Products, Inc.

<b>DATE OF REQUEST:</b>		<b>NAME OF REQUESTOR:</b>	
<b>COMPANY NAME:</b>			
<b>PHONE NUMBER:</b>		<b>EMAIL ADDRESS:</b>	
<b>TYPE OF CREDIT:</b> <input type="checkbox"/> Pricing <input type="checkbox"/> Freight <input type="checkbox"/> Other			
<b>AMOUNT REQUESTED:</b>		<b>ORIGINAL INVOICE NUMBER:</b>	
<b>ADDITIONAL REMARKS:</b>			
<b>SIGNATURE:</b>			<b>DATE SIGNED:</b>
<b>FOR OFFICE USE ONLY</b>			
<input type="checkbox"/> Not Approved, Reason:			
<input type="checkbox"/> Approved		GL Number:	Credit Memo:
<b>REVIEWED BY:</b>		<b>SIGNED:</b>	Date:
<input type="checkbox"/> CUSTOMER NOTIFIED		Initials:	Date:



# EXHIBITION SPONSORSHIP

Survitec Group exhibits at national and international tradeshows, expos and other events throughout the world. We recognize the value in further support for local and regional events in which our customers host or participate. To provide a structured method for supporting these efforts, Survitec Group initiated the Exhibition Sponsorship program in 2013. The goal is to leverage customer space and participation at events that Survitec Group is not exhibiting.

This is how it works for each customer:

1. The customer sends a completed Exhibition Sponsorship Request form (shown below left) to the Survitec Group Sales Manager and Marketing Manager.  
The document may be downloaded from <http://www.survittegroup/uploads/files/SDFESR1A.pdf>
2. It should describe the Survitec Group brands and products that the customer plans to display, and what percentage of booth space is dedicated exclusively to those materials. The percentage of space should match the percentage of booth expense, for which the customer wants to receive reimbursement.
4. If the request is approved, the customer should exhibit and document their participation with specific photography proving product placement (detailed on the form).
5. When the event is complete, the customer should send the photographs and an invoice which proves the cost of the booth expense to the Survitec Group Marketing Manager.

The form may be downloaded from <http://www.survittegroup.com/uploads/files/SDFCUC1A.pdf>

**survittegroup** **EXHIBITION SPONSORSHIP REQUEST**  
If you need additional information, please contact your Sales Manager.

**PURPOSE:** Our exhibition sponsorship goal is to improve preferential placement of marketing materials in customer and sales representative booth/space. This is not a code plan.

**HOW TO:**

1. This form must be completed fully and sent with documentation showing exhibition cost and sub-space to [jonathan.fisher@survittegroup.com](mailto:jonathan.fisher@survittegroup.com)
2. If approved for sponsorship, exhibitor must display marketing materials prominently. Prominence of materials is directly related to the percentage of cost eligible for sponsorship (i.e. materials in 25% of booth = 25% maximum sponsorship).
3. To demonstrate proof of performance, high-resolution photographs must be supplied after event. Low-resolution camera images cannot be accepted. Minimum resolution of each photo is 1500 pixels by 900 pixels.
4. The following 5 photos should be provided to meet this requirement: photo of full booth showing all contents from aisle, from 2 angles; 2 photos of section/percentage of booth related to sponsorship, which should illustrate the prominence of materials; 1 additional close-up/medium-range photo on products in booth.
5. If people are included in photo, please provide the correct spelling of their names as well as a brief description of who they are (company sales manager, rep, etc.). Photos and details must be sent electronically to [marketing-esp@survittegroup.com](mailto:marketing-esp@survittegroup.com) within 60 days of the event to receive sponsorship fulfillment.
6. If all documentation is received according to the steps above, the approved sponsorship will be fulfilled via credit memo with 2 weeks after receipt of photographs.

**PLEASE COMPLETE FULLY**

**NAME OF EVENT:** \_\_\_\_\_

**EVENT DURATION:** Begins (m/d/yyyy) \_\_\_\_\_ Ends (m/d/yyyy) \_\_\_\_\_

**EVENT LOCATION:** \_\_\_\_\_

**BRIEF EVENT DESCRIPTION:** \_\_\_\_\_

**BRAND(S) PROMOTED IN / AT EXHIBITION:**

Survitec Group  Survitec Survival Products (Bertha)  Survitec Zodiac (Bertha)  OOB (Bertha)  
 RFD (Bertha)  Eilat (Bertha)  Crossover (Bertha)  Crossover Personal Flotation  
 Imperial Personal Flotation  Imperial Immersion Suits  Pairo Wessco Pyrotechnics  
 McMurdo Electronics  Kamead Marine Electronics  Fast Find Electronics  Diamond Lights  
 Electric Fuel Lights

**EXHIBITION SIZE:** \_\_\_\_\_ sq ft **\*COST FOR SPACE:** \$ \_\_\_\_\_

\* Validation documentation required that shows size of exhibition and cost for space

**% OF COST REQUESTED:**  10%  25%  50%  75%  100% (Other): \_\_\_\_\_ **AMOUNT:** \$ \_\_\_\_\_

**NAME OF REQUESTOR:** \_\_\_\_\_ **TITLE:** \_\_\_\_\_

**NAME OF COMPANY:** \_\_\_\_\_ **TODAY'S DATE:** \_\_\_\_\_

**FOR OFFICE USE ONLY**

**DATE RECEIVED:** \_\_\_\_\_

**DECISION TO APPROVE:**  Full amount requested approved  Amount requested revised to: \_\_\_\_\_

**DECISION TO DECLINE:**  Event is ineligible  Amount is ineligible

**NOTES:** \_\_\_\_\_

**SIGNED:** \_\_\_\_\_

**PRINTED NAME:** \_\_\_\_\_



**survittegroup** **Survitec Group**  
Survitec Survival Products, Inc.  
11679 Central Commerce Circle, Building 5, Suite 100, Jacksonville, FL 32226 USA  
Tel: +1 904 982 3300 / Fax: +1 904 982 3341 / Email: [jacob@survittegroup.com](mailto:jacob@survittegroup.com) / [www.survittegroup.com](http://www.survittegroup.com)

**CUSTOMER CREDIT REQUEST**  
Please complete fully to request a credit from Survitec Survival Products, Inc.

**DATE OF REQUEST:** \_\_\_\_\_ **NAME OF REQUESTOR:** \_\_\_\_\_

**COMPANY NAME:** \_\_\_\_\_

**PHONE NUMBER:** \_\_\_\_\_ **EMAIL ADDRESS:** \_\_\_\_\_

**TYPE OF CREDIT:**  Pricing  Freight  Other

**AMOUNT REQUESTED:** \_\_\_\_\_ **ORIGINAL INVOICE NUMBER:** \_\_\_\_\_

**ADDITIONAL REMARKS:** \_\_\_\_\_

**SIGNATURE:** \_\_\_\_\_ **DATE SIGNED:** \_\_\_\_\_

**FOR OFFICE USE ONLY**

Not Approved, Reason: \_\_\_\_\_





Approved **GL Number:** \_\_\_\_\_ **Credit Memo:** \_\_\_\_\_





**REVIEWED BY:** \_\_\_\_\_ **SIGNED:** \_\_\_\_\_ **Date:** \_\_\_\_\_





**CUSTOMER NOTIFIED** **Initials:** \_\_\_\_\_ **Date:** \_\_\_\_\_















PRODUCT DESCRIPTION PRODUCT # • DETAILS	SG JV	IMAGE
<b>Dummy - McMurdo Fast Find Max-G PLB</b> M10-85-886-001A		
<b>Dummy - McMurdo Fast Find 220 PLB w/GPS</b> M10-91-001-220A		
<b>Dummy - McMurdo Fast Find Ranger PLB</b> M10-85-520-005A		
<b>Dummy - McMurdo EPIRB Breakthru HRU</b> M10-57501-DUMMY		
<b>Dummy - McMurdo SmartFind + G5 EPIRB with Manual Bracket</b> M10-82-800-005A		
<b>Dummy - McMurdo SmartFind + G5 EPIRB Auto Housing and HRU</b> M10-82-800-006A		
<b>Dummy - McMurdo S4 Rescuer SART</b> M10-86-525-001		
<b>Dummy - McMurdo SmartFind S5 AIS SART</b> M10-92-001-101A		
<b>Dummy - McMurdo SmartFind S20 Unweighted</b> M98-002-013A		
<b>Dummy - McMurdo SmartFind S10 Unweighted</b> M10-98-052-001A		
<b>Sample - McMurdo Grab Bag</b> M10-87-300 • Limited Qty Available		
<b>Sample - McMurdo Grab Bag XL</b> M10-87-313 • Limited Qty Available		

PRODUCT DESCRIPTION PRODUCT # • DETAILS	SG JV	IMAGE
<b>ITEMS BELOW AVAILABLE FOR CENTRAL AND SOUTH AMERICA</b>		
<b>Dummy - Kannad Marine SafeLink Pro PLB</b> M10-K85-886-004A		
<b>Dummy - Kannad Marine Sportpro + GPS EPIRB with Manual Bracket</b> Call		
<b>Dummy - Kannad Marine Sportpro + GPS EPIRB Auto Housing and HRU</b> Call		NO PHOTO AVAILABLE
<b>Dummy - Kannad Marine Rescuer 2 SART</b> M10-86-525-002		
<b>Dummy - Kannad Marine SafeLink AIS SART</b> M10-K92-001-102A		
<b>Dummy - Kannad Marine SafeLink R10 Unweighted</b> M10-98-002-001A		
<b>Sample - Kannad Marine Grab Bag</b> M10-K87-300-002A • Limited Qty Available		NO PHOTO AVAILABLE



PRODUCT DESCRIPTION PRODUCT # • DETAILS	SG JV	IMAGE
<b>Dummy - Pains Wessex Linethrower 250 Body</b> M30-50070 • Limited Qty Available		
<b>Dummy - Pains Wessex Linethrower 250 Rocket</b> M30-50080 • Limited Qty Available		
<b>Dummy - Pains Wessex Parachute Red Rocket</b> M30-50672		
<b>Dummy - Pains Wessex White Collision Hand Flare</b> M30-52751		
<b>Dummy - Pains Wessex Red Hand Flare</b> M30-52900		
<b>Dummy - Pains Wessex Lifesmoke</b> M30-53685		
<b>Dummy - Personal Distress Signal Miniflare Kit</b> M30-55665		
<b>Dummy - Pains Wessex Day/Night Distress Signal</b> M30-55970		
<b>Dummy - Pains Wessex Manoverboard</b> M30-53775 • Limited Qty Available		

PRODUCT DESCRIPTION PRODUCT # • DETAILS	SG JV	IMAGE
<b>Sample - Daniamant M3 Manual Lifejacket Light</b> M10-1130-M3 • Limited Qty Available		
<b>Sample - Daniamant W3 Automatic Lifejacket Light</b> M10-1330-W3 • Limited Qty Available		
<b>Sample - Daniamant L162 Lifebuoy Light</b> M10-62-004AL162 • Limited Qty Available		
<b>Sample - Daniamant L163 Lifebuoy Light</b> M10-62-003AL163 • Limited Qty Available		
<b>Sample - Electric Fuel SLX Auto/Manual Lifejacket Light</b> M10-SLX • Limited Qty Available		



PRODUCT DESCRIPTION PRODUCT # • DETAILS	SG JV	IMAGE
<b>Catalog - Survitec Group North America Commercial Marine</b> M00-SCCPC02A • 114 Pages Limited Qty Available		
<b>Brochure - Survitec Group Above and Beyond</b> /LITERATURE • 18 Pages Order In Multiples of 5		
<b>Brochure - Survitec Group Global Services</b> /LITERATURE • 8 Pages Order In Multiples of 5		
<b>Folder - Survitec Group Global Services Proposal</b> /LITERATURE • 1 Pocket Order In Multiples of 5		
<b>Folder - Survitec Group Marine Evacuation Systems</b> /LITERATURE • 1 Pocket Order In Multiples of 5		
<b>Flier - Crewsaver Personnel Recovery Device (CPRD)</b> /LITERATURE • 2 Sided Order In Multiples of 10		



PRODUCT DESCRIPTION PRODUCT # • DETAILS	SG JV	IMAGE
<b>Brochure - McMurdo Safety For Professionals</b> M00-MCBSFP1A • 33 Pages Order In Multiples of 10		
<b>Brochure - McMurdo SmartFind S10 Personal AIS</b> M00-MCBSS10A • Tri-fold Order In Multiples of 25		
<b>Brochure - McMurdo SmartFind S20 Personal AIS</b> M00-MCBSS20A • Tri-fold Order In Multiples of 25		NO PHOTO AVAILABLE
<b>Brochure - McMurdo Fast Find 220 PLB</b> M00-MCBFF02A • Tri-fold Order In Multiples of 25		
<b>Brochure - McMurdo Fast Find Ranger PLB</b> M00-MCBFF03A • Tri-fold Order In Multiples of 25		
<b>Brochure - Kannad Marine</b> M00-KCBKM01A • 26 Pages Order In Multiples of 10		
<b>Brochure - Kannad Marine SafeLink R10 Personal AIS</b> M00-KCBSL01A • Tri-fold Order In Multiples of 25		
<b>Brochure - Kannad Marine SafeLink Solo PLB</b> M00-KCBSL02A • Tri-fold Order In Multiples of 25		

PRODUCT DESCRIPTION PRODUCT # • DETAILS	SG JV	IMAGE
<b>McMurdo / Kannad Plastic Brochure Holder</b> M00-MOLHT001A • Order With POPs below marked with ***		
<b>POP Display - McMurdo SmartFind EPIRB ***</b> M00-POPMSPSF01A		
<b>POP Display - McMurdo SmartFind S10 ***</b> M00-POPPLS10		
<b>POP Display - McMurdo SmartFind S20 ***</b> Call for availability		NO PHOTO AVAILABLE
<b>POP Display - McMurdo Fast Find 220</b> M00-POPFF220 • Limited Qty Available		
<b>POP Display - McMurdo 3-Product Metal Display</b> M00-MDISPLAY02 • Produced for requestor on demand at cost of fabrication		
<b>POP Display - Kannad Marine Boat Safe ***</b> Call for availability		
<b>POP Display - Kannad Marine SafeLink Solo ***</b> Call for availability		
<b>POP Display - Kannad Marine SafeLink R10 ***</b> Call for availability		
<b>POP Display - Kannad Marine Metal 3-Product Display</b> M00-MDISPLAY01 • Produced for requestor on demand at cost of fabrication		
<b>POP Display - Pains Wessex Metal 7-Product Display</b> M00-MDISPLAY03 • Produced for requestor on demand at cost of fabrication		NO PHOTO AVAILABLE

PRODUCT DESCRIPTION PRODUCT # • DETAILS	SG JV	IMAGE
<b>West Marine POP Kit - Kannad Marine R10</b> M00-WMPOP001 • Available to West Marine Only		NO PHOTO AVAILABLE
<b>West Marine POP Kit - McMurdo Fast Find 220</b> M00-WMPOP002 • Available to West Marine Only		NO PHOTO AVAILABLE
<b>West Marine POP Kit - McMurdo SmartFind Plus G5</b> M00-WMPOP003 • Available to West Marine Only		NO PHOTO AVAILABLE
<b>Banner - Survitec Group White 72x36</b> M00-SSB0001A • Limited Qty Available		NO PHOTO AVAILABLE
<b>Banner - Survitec Group Black 72x36</b> M00-SSB0001B • Limited Qty Available		NO PHOTO AVAILABLE
<b>Banner - Survitec Group White 16x12</b> M00-SSB0001C • Limited Qty Available		NO PHOTO AVAILABLE
<b>Banner - Survitec Group Black 16x12</b> M00-SSB0001D • Limited Qty Available		NO PHOTO AVAILABLE
<b>Banner - McMurdo 60x36</b> M00-SSB0007B • Limited Qty Available		
SSB0007A • Limited Qty Available <b>Banner - McMurdo 48x24</b>		



PRODUCT DESCRIPTION PRODUCT # • DETAILS	SG JV	IMAGE
<b>Sample - SG Men's T-Shirt (size indicated in product #)</b> M00-TSHIRT01-S M00-TSHIRT01-M M00-TSHIRT01-L M00-TSHIRT01-XL M00-TSHIRT01-2XL M00-TSHIRT01-3XL Limited Qty Available		
<b>Sample - SG Women's T-Shirt (size indicated in product #)</b> M00-TSHIRT02-S M00-TSHIRT02-M M00-TSHIRT02-L M00-TSHIRT02-XL M00-TSHIRT02-2XL M00-TSHIRT02-3XL Limited Qty Available		
<b>Sample - Survitec Group Flare Black Baseball Cap</b> /APPAREL • Limited Qty Available		

PRODUCT DESCRIPTION PRODUCT # • DETAILS	SG JV	IMAGE
<b>Sample - Survitec Group Black Coffee Mug</b> M00-COFFEEMUG01 • Limited Qty Available		NO PHOTO AVAILABLE
<b>Sample - Survitec Group Black Backpack Cinch Bag</b> M00-SPB0001A • Limited Qty Available		NO PHOTO AVAILABLE
<b>Sample - Survitec Group USB Drive</b> M00-USB-SUR01 • Call for availability		NO PHOTO AVAILABLE
<b>Sample - Survitec Group Pen</b> M00-PEN-SUR01 • Limited Qty Available		
<b>Sample - McMurdo Pen</b> M00-PEN-MCM01 • Limited Qty Available		
<b>Sample - Kannad Marine Pen</b> M00-PEN-KAM01 • Limited Qty Available		

THIS PAGE INTENTIONALLY LEFT BLANK

# DOING BUSINESS WITH SURVITEC

Welcome To The Family	1101
Setting Up Your Account	1102
Survitec Survivor Club	1103

## Online Tools:

Public Website	1104
Spare Parts Ordering Site	1105
Technical Publications	1105
FTP Site	1106



# WELCOME TO OUR FAMILY

Survitec Group believes in relationships. We have built our business on strong partnerships with our customers and suppliers. Whether it is offshore, leisure and passenger ships, workboats or beyond, you can count on Survitec to deliver the best in commercial Marine products, services and support. We appreciate your business and look forward to a mutually successful future.

## RETAIL AND SUPPLY CUSTOMERS

Our customers come in all shapes and sizes. To help better serve the wide variety of needs, we have identified three primary levels of customer:

- Distributor
- Master Distributor
- Elite Distributor

Each level has terms which are specific to that particular program. Payment and shipping policies, applicable territories and advertising allowances are examples of terms that are included. Please contact your Sales Manager to discuss a program that is best for you.

## SERVICE STATION CUSTOMERS

Among our most important customers are Certified Survitec Group Service Stations. We believe it takes strong partnerships with service stations to bring the highest quality, best value survival products to end user customers.

Because what you do is so important to the safety of those who depend on our products, we have significant technical and support resources available to you when required.



# SETTING UP YOUR ACCOUNT

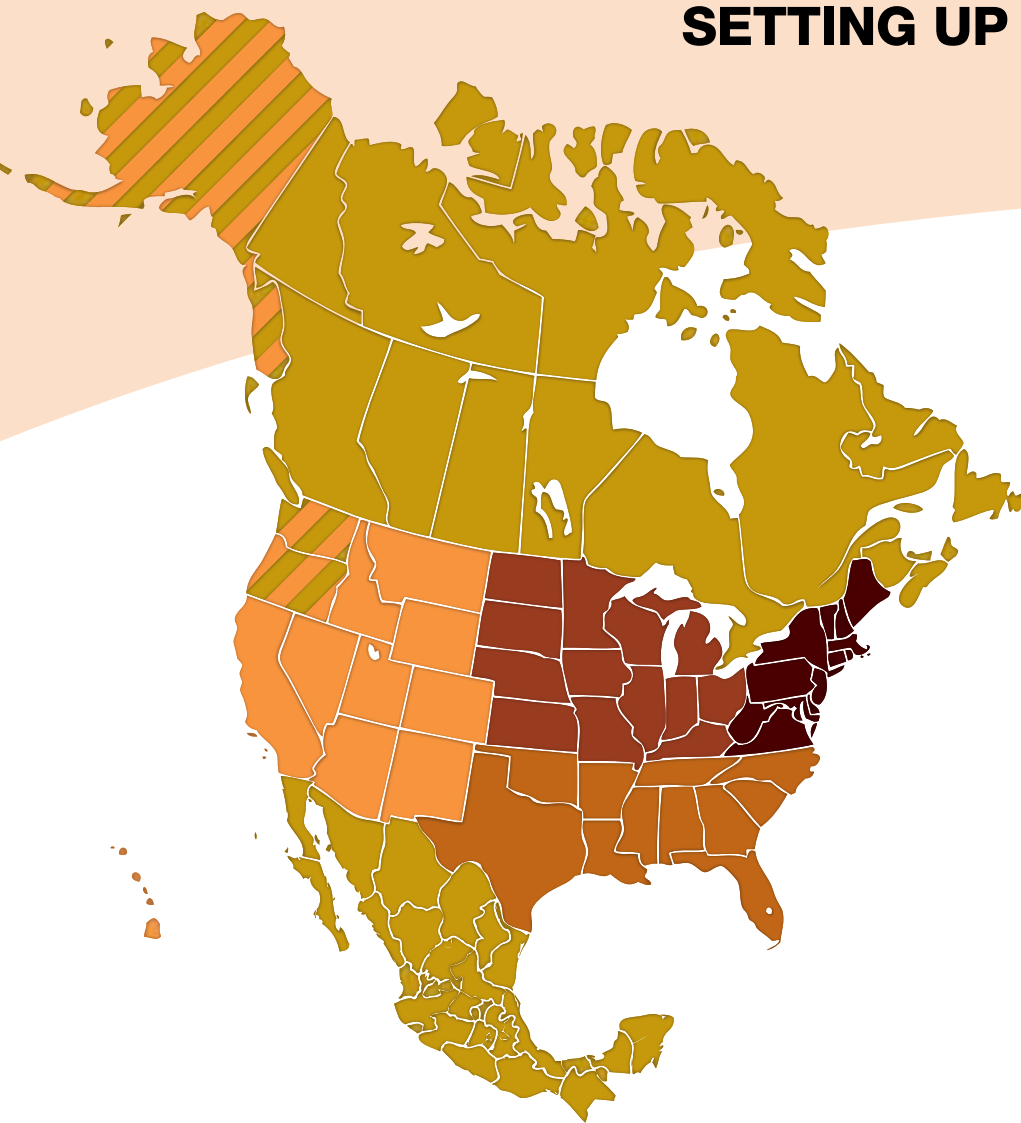

Meeting your needs is our priority, and we know that one size doesn't fit all. Each of our locations specializes in particular brands and product categories, with key support expertise to help with your ordering and technical questions.

In order to do business we need to set up your account, establish terms, get you a customer program and pricing. Depending on where you are located will determine who should walk you through the process.

Our Managers are the best in the business with nearly 100 years of combined experience in the industry.

Please refer to the map and contacts below.

U.S. Director of Sales and Marketing	<b>T.J. Tracy</b> • 410-299-6724 tj.tracy@survitecgroup.com
U.S. Pacific Northwest, Alaska, Canada, Mexico, Central and South America Sales Director	<b>Mark Hansen</b> • 604-375-9295 mark.hansen@survitecgroup.com
U.S. Western Region, Alaska and International Sales Manager	<b>Mark Hansen</b> • 604-375-9295 mark.hansen@survitecgroup.com
U.S. Southeast, Gulf Coast and Caribbean Sales Manager	<b>Tim Hazen</b> • 904-487-8444 tim.hazen@survitecgroup.com
U.S. Midwest Sales and Account Services Manager	<b>Connie Schreifels</b> • 904-465-2518 connie.schreifels@survitecgroup.com
U.S. Northeast Sales Manager	<b>Andy Hiller</b> • 904-487-8440 andy.hiller@survitecgroup.com



Survitec Group is recognized as the worldwide leader in the manufacturing, supply, inspection, testing and maintenance of mission-critical safety and survival equipment. We have been helping to save lives at sea for over 160 years. From common-use safety items to products of last resort, our equipment and services are respected and relied upon in all corners of the world.

In 2013, Survitec Group North America introduced the Survitec Survivor Club. We know that our products must work the right way, at the right time, every time. As such, feedback from the survivors who have used our products in life-threatening situations is an extremely critical part of our product improvement process.

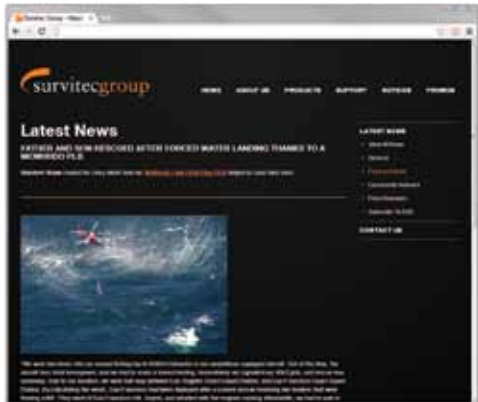

It is the policy of Survitec Group in North America to replace certain products free-of-charge (\*) when they have been used in a life-threatening situation, have saved a life, AND have been properly documented with an appropriate regulating agency, such as the U.S. or Canadian Coast Guard authorities. Following notice of a survival event, the process works as follows:

1. The Survivor contacts the distributor or dealer from whom he or she purchased the applicable product (electronics, liferafts, PFDs, immersion suits), and provides basic details of the survival event including dates, times, and product label or serial number information.



2. That distributor or dealer contacts Survitec Group at the location from where they ordered the product (example: Jacksonville) to report the event and provide the same information. This begins the replacement process.

3. Survitec Group or the distributor/dealer will contact the Survivor to see if he or she can provide testimonials and photos that document his or her experience. Factual information such as location, time, number of passengers, vessel type, equipment deployed, weather conditions, etc. is very important. Survitec Group will provide the applicable documentation forms and other support information when the time is appropriate. Survitec Group will also need the incident report information from the appropriate regulating authority.

4. When the requested information is in hand, Survitec Group will enact a free replacement to be sent directly to the Survivor or via the distributor. The Survivor will also be recognized in a personal letter from the Survitec Group Chief Executive Officer (CEO) as an inductee into the Survitec Survivor Club.

5. Depending on the circumstances, Survitec Group may request written permission to recognize the Survivor for his or her actions, which will be coordinated with the Survitec Group Sales and Marketing team and with the appropriate distributor or dealer.

\* Please contact your Sales Manager for program rules and details.

# PUBLIC WEBSITE



Survitec Group launched our new website in 2013, which covers everything we offer throughout the world.

It includes many exciting features such as a streamlined interface, filtered queries, searchable maps and many other functional improvements.

Some of the key content areas include:

- About
- News & Events
- Industries
- Products
- Sectors
- Services
- Brands
- Careers

It is also smart phone and tablet -friendly with dynamic page sizing to best suit the presentation size of the device it may be displayed on.

Scan the QR Code below to visit our website. We welcome any feedback you have on navigation, content or other opportunities for improving your browsing experience.



<http://www.survitecgroup.com>

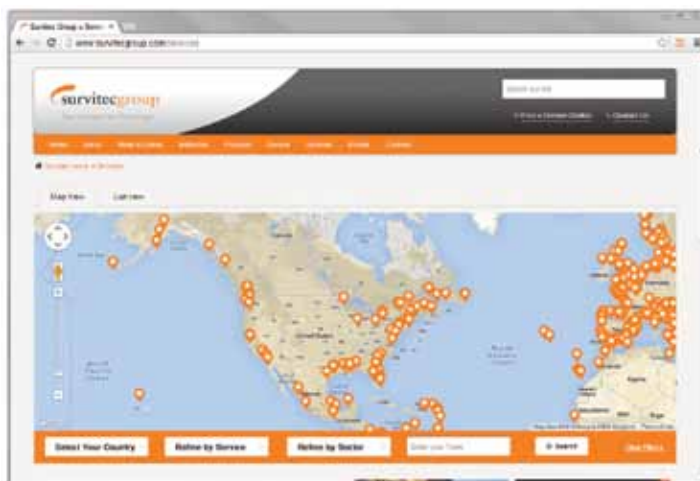
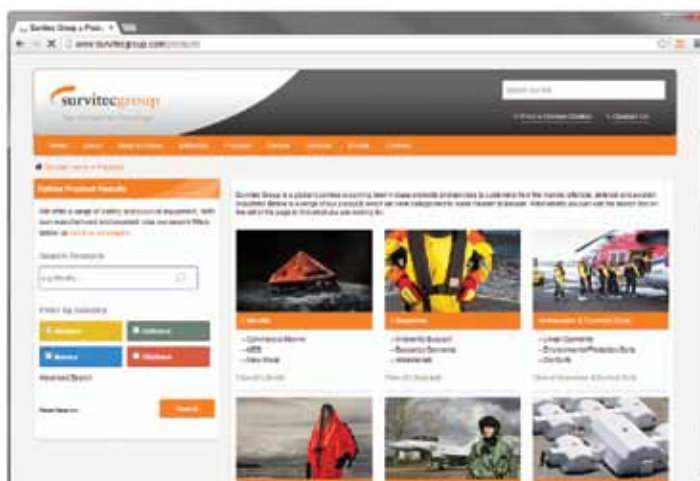

# SERVICE STATION ONLINE RESOURCES

## ONLINE SPARE PARTS DATABASE

To streamline the ordering process for spare parts and service materials, Survitec Group has developed an online site where you can reference photographs, specifications, part numbers, then submit your order directly.

A login is required, so please contact Survitec Group in Vancouver in order to set-up your access.

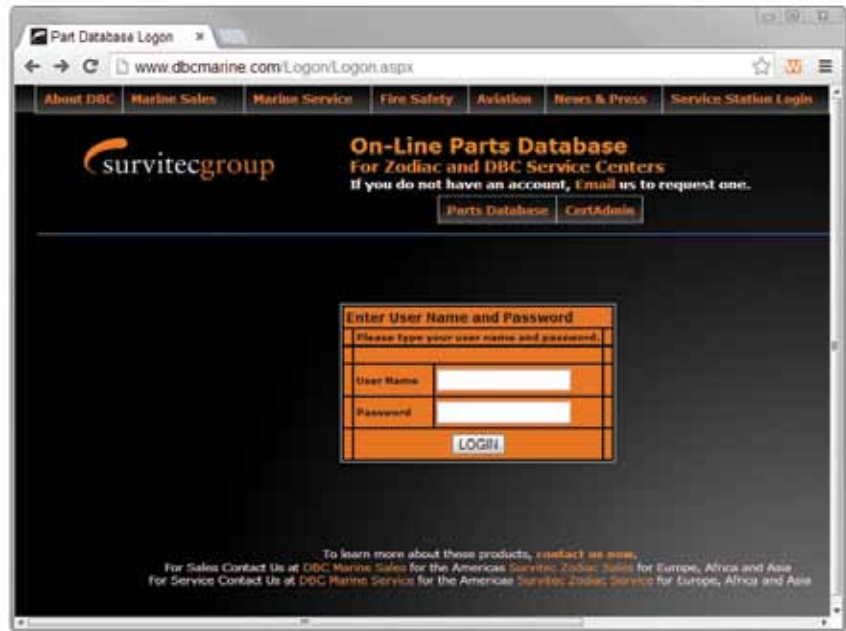

<http://www.dbcmarine.com/Logon/Logon.aspx>

## TECH PUBS AND CERTIFICATES

Managing your certificates can be daunting with all the brands available, and the multitudes of customers that need your help.

Fortunately, Survitec Group has just the solution... a website that allows you quick and easy access to your certificate information, allows you to order new certificates, and hosts a wealth of technical publications available anytime.

A login is required to access certificates, so please be sure to register so your access can be provided.

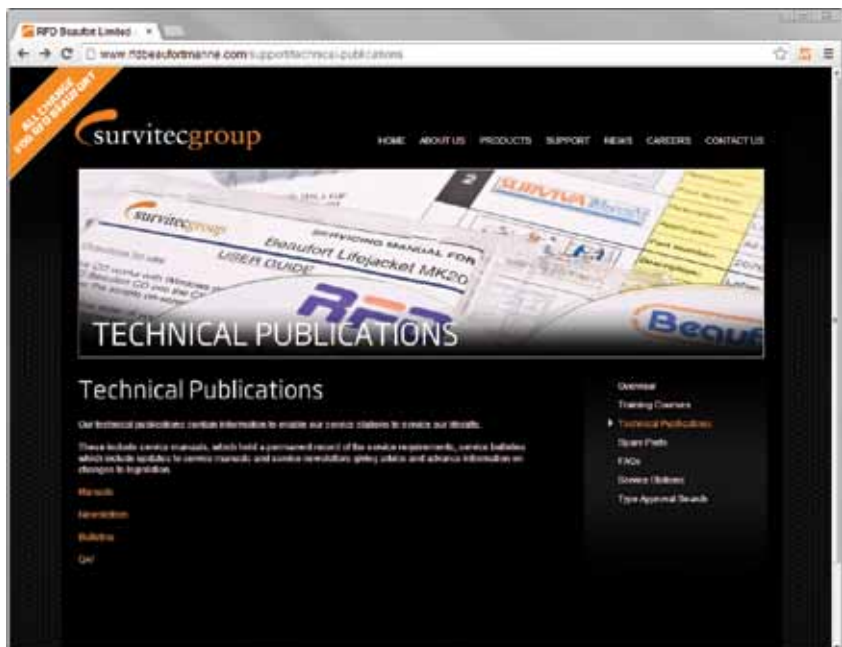

<http://www.rfdbeaufortmarine.com/support/technical-publications>



# FTP RESOURCE SITE

Survitec Group includes graphic and informational content on our website for public use. Many of our customers also publish their own catalogs, maintain websites and distribute other materials through various methods to their target end user customers.

Often, these materials require high resolution photography, logos and other content that is not made freely available through the Survitec Group website to the general public. These digital files can be very large, in some cases 30MB and more. This large size exceeds the limits for email attachments from Survitec Group.

Our File Transfer Protocol (or FTP) site is specifically suited for providing secured access of these items to customers, 24-hours a day, on-demand. To connect with the FTP site, a special transfer application, called a client must be installed on your computer. Below are the directions to access the site:

1. Contact your Sales Manager for permission to access the FTP site
2. You will be provided with a credentials file (ftp\_publicaccess@sgusaftp.com.xml)
3. Save this file to your computer
4. Open your internet browser (ex: Google Chrome, Internet Explorer, Mozilla Firefox, Apple Safari)
5. Go to <http://filezilla-project.org/>
6. Left-click on the “Download FileZilla Client” button to access the downloads page
7. There are several versions of the FileZilla Client
8. Left-click on the appropriate link based on your computer’s operating system
9. The program should begin to download
10. When it has finished, double-click it so the installation begins
11. Go through the prompts that follow, selecting the location of where it should be installed
12. After it is done, you will be prompted to decide if you want to run FileZilla
13. Run FileZilla
14. In the menu at the top, left-click “File”
15. Left-click “Import”
16. Browse to the location of the credentials file that you saved to your computer
17. That will create a listing in your site manager (FileZilla can access multiple FTP servers)
18. In the menu at the top, left-click “File”
19. Left-click “Site Manager”
20. Select ftp.sgusaftp.com and left-click Connect button
21. You are now directly connected to the FTP server
22. A screenshot of the window is labeled below left

To download files from the FTP site to your computer, browse to them in the Server Directory Window and drag from the Server Directory Contents to the Client Computer Directory Contents. You can track progress in the upload/download queue window.

- A. Communication Indicator Window
- B. Client Computer Directory Window
- C. Server Directory Window
- D. Client Computer Directory Contents
- E. Server Directory Contents
- F. Upload/Download Queue Window

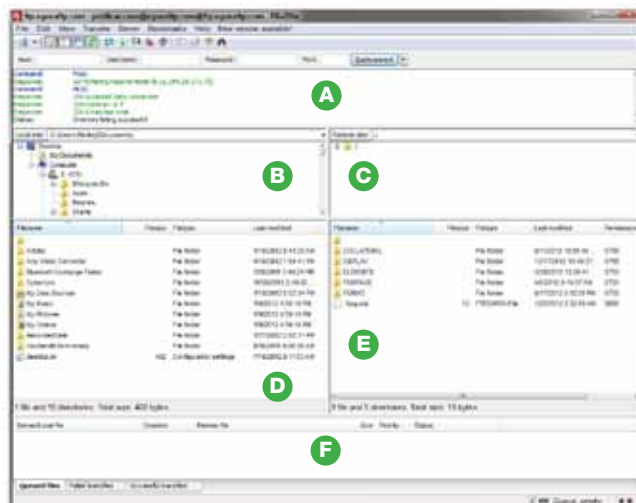

THIS PAGE INTENTIONALLY LEFT BLANK





## **COPYRIGHT NOTICE**

The copyright, trademarks, domain names and other intellectual property rights in all material and information in this presentation belongs to Survitec Group Limited. All rights are reserved.

## **DISCLAIMER**

This catalog provides general information about Survitec Group and its companies, its products and services, and summarizes general capabilities and offerings which we deem to be of relevance to our customers. Whilst Survitec has taken appropriate steps to ensure the accuracy of the information contained in this document, Survitec gives no warranty regarding the accuracy or completeness of such information.

This presentation was prepared to provide information and does not constitute a contract.

Survitec reserves the right, without prior notice, to change, delete, supplement, or otherwise amend at any time the information, images, and offerings contained in this presentation, or other documents. Survitec shall not be liable for any loss or damage of whatever nature (whether direct, indirect, consequential or other) that may arise as a result of any third party relying on the information contained in this document (but nothing in this disclaimer excludes liability for death or personal injury arising from negligence or any fraudulent misrepresentation). The information, rules, policies, procedures and other content listed in this edition supercede the information, rules, policies, procedures and other content listed in previous editions.

For further detailed information, prices, terms and conditions, customers should contact Survitec Group.

